MANUAL

MODEL **1230**

**MultiMode™ AC INDUCTION
MOTOR CONTROLLER**

© 2007 CURTIS INSTRUMENTS, INC.

DESIGN OF CURTIS 1200 SERIES
CONTROLLERS PROTECTED BY U.S.
PATENT NO. 4626750.

1230 Manual, p/n 37092
Rev. C: October 2007



CURTIS INSTRUMENTS, INC.

200 Kisco Avenue
Mt. Kisco, New York 10549 USA
Tel. 914.666.2971
Fax 914.666.2188

www.curtisinstruments.com

CONTENTS

| | |
|---|----|
| 1. OVERVIEW | 1 |
| 2. INSTALLATION AND WIRING..... | 4 |
| Mounting the Controller | 4 |
| Connections: Low Current..... | 6 |
| Connections: High Current | 7 |
| Wiring: Standard Configuration A, no multiplexer | 8 |
| Wiring: Standard Configuration B, with multiplexer | 10 |
| Wiring: Standard Configuration C, with multiplexer and a proportional valve on the hydraulic line..... | 12 |
| Wiring: Throttles | 14 |
| 5k Ω -0 two-wire resistive throttle (“Type 1”)..... | 15 |
| Single-ended 0-5V, current source, and 3-wire pot throttles (“Type 2”) | 15 |
| 0-5k Ω two-wire resistive throttle (“Type 3”)..... | 17 |
| Wigwag 0-5V and 3-wire pot throttles (“Type 4”)..... | 17 |
| Three-step switch throttle (“Type 5”) | 18 |
| Wiring: Auxiliary Drivers..... | 18 |
| Wiring: Emergency Reverse | 18 |
| Wiring: Emergency Reverse Check | 19 |
| Wiring: Spyglass Display..... | 19 |
| Wiring: Tiller Multiplexer | 20 |
| Contactor, Switches, and Other Hardware..... | 20 |
| 3. PROGRAMMABLE PARAMETERS | 23 |
| <i>Vehicle Parameters</i> | |
| Rate Parameters..... | 25 |
| Acceleration Rate, Deceleration Rate, Brake Rate, Fast Stop Rate, Accel Release Rate | |
| Speed Parameters | 26 |
| Minimum Speed, Maximum Speed, Speed Limit Type | |
| MultiMode Parameters..... | 27 |
| Mode Select Type, Coast Decel Rate, Anti-Tiedown | |
| Throttle Parameters..... | 28 |
| Throttle Type, Throttle Deadband, Throttle Maximum, Throttle Map, Pot Low Check | |

| | |
|--|----|
| Sequencing Parameters..... | 30 |
| Interlock Normally Open, Sequencing Delay, SRO, HPD, Main Contactor Interlock Type, Main Contactor Open Delay, Main Contactor Check | |
| Brake Parameters..... | 32 |
| Brake Fault Check, Brake Delay, Brake Hold Voltage, Brake Driver Type, Anti-Rollback Time | |
| Emergency Reverse Parameters | 33 |
| Wiring Check, Speed, Direction Interlock, Time Limit, Accel Rate, Switch Normally Closed | |

Motor & Control Parameters

| | |
|--|----|
| Motor Parameters | 35 |
| Min Motor Voltage, Nominal Motor Voltage, Nominal Motor Frequency, Max Motor Speed, Number of Motor Poles, Encoder Pulses Per Revolution, Swap Encoder Direction, Failsafe Delay | |
| Control Parameters | 36 |
| P Gain, I Gain, Accel Slip, Regen Slip, Slip Boost, Pull-Out Slip, Accel Slip Voltage, Regen Slip Voltage, Accel Comp, Regen Comp, Regen Voltage Offset | |

System Parameters

| | |
|---|----|
| Battery Parameters | 38 |
| Full Battery Voltage, Empty Battery Voltage, BDI Reset Battery Voltage, Battery Recharge Level, Low Voltage Level | |
| Hourmeter Parameters | 39 |
| Enable Total Service Hours, Enable Drive Service Hours, Adjust Hours, Set Total Hours, Set Drive Hours, Total Service Hours, Drive Service Hours, Total Disable Hours, Drive Disable Hours, Drive Disable Speed, Service Total Expired, Service Drive Expired | |

| | | |
|--|-----|--|
| Hydraulics Parameters..... | 40 | |
| Lift PV Max, Lift PV Min, | | |
| Lift PV Accel Rate, Lift PV Decel Rate, | | |
| Lower PV Max, Lower PV Min, | | |
| Lower PV Accel Rate, Lower PV Decel Rate, | | |
| PV Dither, Pump Start Delay, | | |
| Pump BDI Lockout, Lift PV Hold Delay, | | |
| Load Hold Delay, Open Load Hold During Lift, | | |
| Hyd Throttle Type, Hyd Throttle Deadband, | | |
| Hyd Throttle Max, Hyd Throttle Map, | | |
| Max Pump Run Time | | |
| Other System Parameters | 43 | |
| Power Save Delay, Mux Inputs Enabled, | | |
| Inhibit Input Type, Auxiliary Output Type, | | |
| Fault Code | | |
| <i>Controller Cloning</i> | 44 | |
| 4. MONITOR MENU | 45 | |
| 5. INITIAL SETUP | 46 | |
| 6. VEHICLE PERFORMANCE ADJUSTMENT | 51 | |
| 7. DIAGNOSTICS AND TROUBLESHOOTING..... | 54 | |
| LED Diagnostics..... | 54 | |
| Spyglass Diagnostics..... | 55 | |
| Programmer Diagnostics | 55 | |
| Troubleshooting Chart..... | 55 | |
| 8. MAINTENANCE | 58 | |
| APPENDIX A Vehicle Design Considerations..... | A-1 | |
| APPENDIX B Programmer Operation and Menus | B-1 | |
| APPENDIX C Specifications | C-1 | |

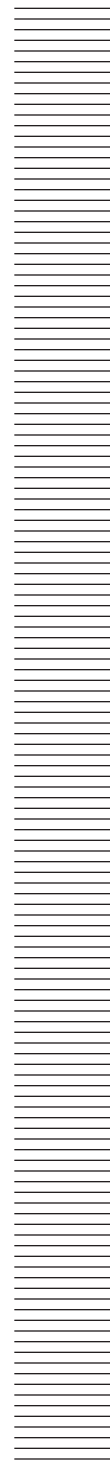

FIGURES

| | | |
|-----------|---|-----|
| FIG. 1: | Curtis 1230 AC motor controller..... | 1 |
| FIG. 2: | Mounting dimensions, Curtis 1230 controller | 4 |
| FIG. 3: | Standard wiring configuration A, for applications without tiller multiplexer | 8 |
| FIG. 4: | Standard wiring configuration B, for applications with tiller multiplexer | 10 |
| FIG. 5: | Standard wiring configuration C, for applications with tiller multiplexer and PV | 12 |
| FIG. 6: | Wiring for 5k Ω -0 potentiometer (“Type 1”) | 15 |
| FIG. 7: | Wiring for 0-5V voltage sources (“Type 2”) | 15 |
| FIG. 8: | Wiring for current source (“Type 2”) | 16 |
| FIG. 9: | Wiring for 3-wire potentiometer (“Type 2”) | 16 |
| FIG. 10: | Wiring for 0-5k Ω potentiometer (“Type 3”) | 17 |
| FIG. 11: | Wiring for wigwag 3-wire potentiometer (“Type 4”)..... | 17 |
| FIG. 12: | Wiring guide and mounting dimensions, Curtis 840 Spyglass display | 19 |
| FIG. 13: | Wiring guide and mounting dimensions, Curtis 1312 Multiplexer..... | 20 |
| FIG. 14: | Influence of various parameters on controller output response to throttle demand | 29 |
| FIG. 15: | Overview of motor control | 34 |
| FIG. 16: | Motor control parameters and their effect on operating characteristics | 34 |
| FIG. 17: | Hydraulic system, configuration B | 40 |
| FIG. 18: | Hydraulic system, configuration C..... | 40 |
| FIG. B-1: | Curtis 1311 programmer | B-1 |

TABLES

| | | |
|------------|---|-----|
| TABLE 1: | Throttle wiper input (threshold values) | 14 |
| TABLE 2: | Three-step switch throttle speeds..... | 18 |
| TABLE 3: | Status LED fault codes | 54 |
| TABLE 4: | Status LED fault categories | 55 |
| TABLE 5: | Troubleshooting chart..... | 56 |
| TABLE C-1: | Specifications, Curtis 1230 controller | C-1 |

1

OVERVIEW

The Curtis 1230 motor controller is an AC induction motor speed controller designed for use in a variety of material handling vehicles. Typical applications include walkie/rider pallet trucks, low lifts, stackers, sweeper/scrubber machines, and other small industrial vehicles. This high performance programmable controller is simple to install, efficient, and cost effective.

Fig. 1 *Curtis 1230
AC motor controller.*



The 1230 controller offers smooth precise control of motor speed and torque. When used with hydraulic systems, the 1230 turns the pump motor on and off and also controls valves on the hydraulic line—thus controlling the hydraulic path for Lift and Lower operations.

These controllers are fully programmable through Curtis's optional 1311 handheld programmer or 1314 PC programming station. The programmer provides diagnostic and test capability in addition to configuration flexibility.

The 1230 is also designed to work with the optional Curtis 840 Spyglass data display and the optional Curtis 1312 tiller multiplexer.

Like all Curtis motor controllers, the 1230 offers superior operator control of motor speed. **Features include:**

- ✓ 60–200 amp AC induction motor controller
- ✓ MultiMode™ feature allows two distinct user-selectable operation modes
- ✓ Programmability through the Curtis 1311 handheld programmer and 1314 PC programming station
- ✓ Complete diagnostics through the 1311 and 1314 programmers and through the controller's built-in Status LED
- ✓ Throttle input for single-ended or wigwag 5kΩ pots or 0–5V throttles (both standard full stroke and restricted range)
- ✓ Active precharge of controller capacitor bank extends life of main contactor tips
- ✓ Two hourmeters—total KSI-on hours and drive hours—and their associated maintenance timers are built into the controller, with EEPROM storage (no battery)
- ✓ BDI calculations performed within controller
- ✓ Meets EEC fault detection requirements
- ✓ Fault detection circuitry on throttle inputs can be used to inhibit operation if throttle signal goes out of range for any reason (applies both to the traction throttle and, in applications that include a proportional valve, to the hydraulic throttle as well)
- ✓ Stall protection
- ✓ Internal reverse polarity protection (no external diode required)
- ✓ Continuous diagnostics during operation, with microprocessor power-on self-test
- ✓ All output drivers are short-circuit protected and provide built-in coil spike protection
- ✓ Positive battery connections for all inputs
- ✓ Fully protected inputs
- ✓ Internal and external watchdog circuits ensure proper software operation
- ✓ High environmental protection rating (IP53)
- ✓ 3-wire serial interface for multifunction display

Additional features on 1230-2X01 models (for use with multiplexer)

- ✓ 4-wire serial interface for all tiller functions
- ✓ Two auxiliary outputs, controlled by switches on the tiller multiplexer, can be used for a lift relay, lowering valve, horn, etc.
- ✓ Internal main contactor for battery reverse polarity protection and additional safety
- ✓ Variable PWM voltage for precise control during lift/lower operation, in applications with a proportional valve

Curtis Model 840 Spyglass Display

- ✓ 3-wire serial interface
- ✓ Sequences between hourmeter, BDI, and error displays
- ✓ Alphanumeric, 8 character, 5 mm LCD display for hourmeter, BDI, and fault messages
- ✓ Operating temperature range -10°C to 70°C; models with lower temperature ratings available for freezer applications

Curtis Model 1312 Tiller Multiplexer

- ✓ 4-wire serial interface increases reliability
- ✓ Multiplexes up to 12 signals, analog or digital
- ✓ All signals sampled 50 times per second
- ✓ Signal integrity checked 150 times per second.

Familiarity with your Curtis controller will help you install and operate it properly. We encourage you to read this manual carefully. If you have questions, please contact the Curtis office nearest you.

2

INSTALLATION AND WIRING

MOUNTING THE CONTROLLER

The 1230 controller can be oriented in any position, and meets the IP53 ratings for environmental protection against dust and water. However, **the location should be carefully chosen to keep the controller clean and dry.** If a clean, dry mounting location cannot be found, a cover must be used to shield the controller from water and contaminants.

When selecting the mounting position, be sure to also take into consideration (1) that the built-in Status LED is visible only through the view port in the label on top of the controller, and (2) that convenient access is needed at the top of the controller to plug the programmer into its connector.

The outline and mounting hole dimensions for the 1230 controller are shown in Figure 2. To ensure full rated power, the controller should be fastened to a clean, flat metal surface with four 6 mm (1/4") diameter bolts, using the

Fig. 2 Mounting dimensions, Curtis 1230 controller.

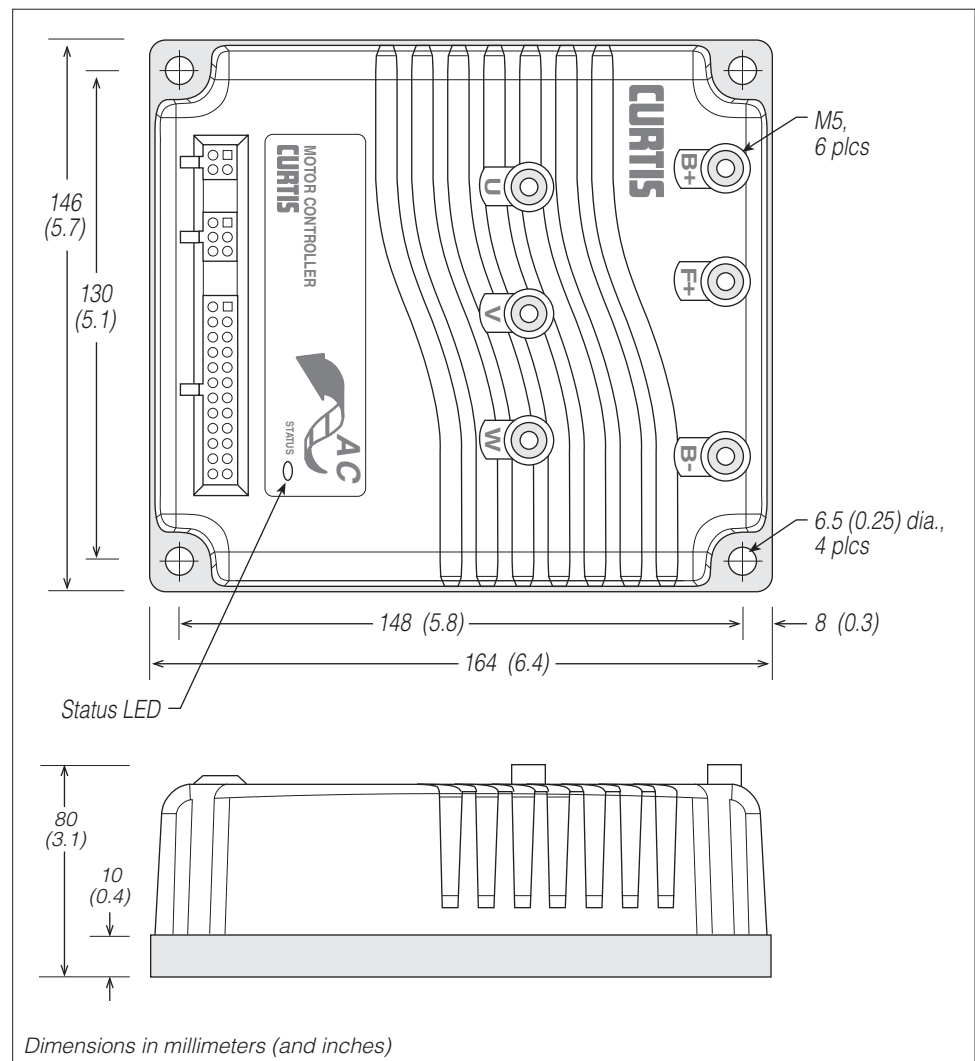

holes provided. Although not usually necessary, a thermal joint compound can be used to improve heat conduction from the controller heatsink to the mounting surface.

You will need to take steps during the design and development of your end product to ensure that its EMC performance complies with applicable regulations; suggestions are presented in Appendix A.



The 1230 controller contains **ESD-sensitive components**. Use appropriate precautions in connecting, disconnecting, and handling the controller. See installation suggestions in Appendix A for protecting the controller from ESD damage.



Working on electrical systems is potentially dangerous. You should protect yourself against uncontrolled operation, high current arcs, and outgassing from lead acid batteries:

UNCONTROLLED OPERATION — Some conditions could cause the motor to run out of control. Disconnect the motor or jack up the vehicle and get the drive wheels off the ground before attempting any work on the motor control circuitry. **NOTE:** If the wrong throttle input signal type is selected with the 13XX programmer, the vehicle may suddenly begin to move.

HIGH CURRENT ARCS — Batteries can supply very high power, and arcs can occur if they are short circuited. Always open the battery circuit before working on the motor control circuit. Wear safety glasses, and use properly insulated tools to prevent shorts.

LEAD ACID BATTERIES — Charging or discharging generates hydrogen gas, which can build up in and around the batteries. Follow the battery manufacturer's safety recommendations. Wear safety glasses.

CONNECTIONS

Low Current Connections

Three low current connectors (J1, J2, J3) are built into the 1230 controller. They are located in a row on the top of the controller:

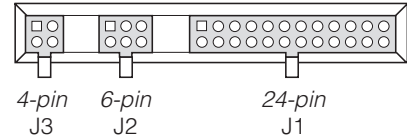

The 24-pin connector (J1) provides the logic control connections for the contactor drivers and switches that are wired directly to the vehicle. The mating connector is a 24-pin Molex Mini-Fit Jr. connector part number 39-01-2245 using type 5556 terminals.

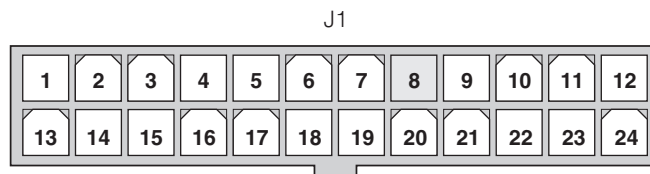

| | | | |
|-----------|--|------------------|------------|
| J1 Pin 1 | keyswitch input (KSI) | | |
| J1 Pin 2 | interlock | | |
| J1 Pin 3 | mode switch input—M1 (open), M2 (closed) | | |
| J1 Pin 4 | inhibit input | | |
| J1 Pin 5 | pot high output | | |
| J1 Pin 6 | wiper/0–5V input for throttle | | |
| J1 Pin 7 | pot low input | | |
| J1 Pin 8 | [not used] | | |
| J1 Pin 9 | feed-through ground | NO MULTIPLEXER | |
| J1 Pin 10 | speed limit input | | |
| J1 Pin 11 | feed-through input 1 | | |
| J1 Pin 12 | feed-through input 2 | | |
| | | WITH MULTIPLEXER | |
| | | J1 Pin 9 | mux supply |
| | | J1 Pin 10 | mux data |
| | | J1 Pin 11 | mux clock |
| | | J1 Pin 12 | mux ground |
| J1 Pin 13 | forward switch input | | |
| J1 Pin 14 | reverse switch input | | |
| J1 Pin 15 | emergency reverse input | | |
| J1 Pin 16 | emergency reverse check output | | |
| J1 Pin 17 | Status LED output | | |
| J1 Pin 18 | Battery LED output | | |
| J1 Pin 19 | display power output | | |
| J1 Pin 20 | display ground reference output | | |
| J1 Pin 21 | display data output | | |
| J1 Pin 22 | main contactor driver output | | |
| J1 Pin 23 | auxiliary output 1 | | |
| J1 Pin 24 | auxiliary output 2 | | |

A 6-pin low power Molex connector (J2) is provided for the speed encoder and electromagnetic brake connections. The mating connector is a Molex Mini-Fit Jr. p/n 39-01-2065 using type 5556 terminals.

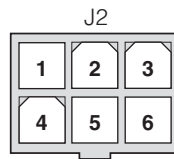

| | |
|-----------------|---------------------------------|
| J2 Pin 1 | encoder power output |
| J2 Pin 2 | encoder A |
| J2 Pin 3 | E-M brake coil return |
| J2 Pin 4 | encoder B |
| J2 Pin 5 | encoder ground reference output |
| J2 Pin 6 | E-M brake driver output |

Note: In some applications using a tiller multiplexer, J2 Pins 3 and 6 are used for a proportional valve instead of an electromagnetic brake.

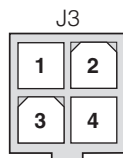

| | |
|-----------------|---------------------|
| J3 Pin 1 | receive data (+5V) |
| J3 Pin 2 | ground (B-) |
| J3 Pin 3 | transmit data (+5V) |
| J3 Pin 4 | +15V supply (100mA) |

A 4-pin low power connector (J3) is provided for the 13XX programmer. A complete programmer kit, including the appropriate connecting cable, can be ordered; see Curtis programmer manual for further information on the various programmers available for programming Curtis controllers.

J3 can also be used for the Curtis Model 840 Spyglass display. Although the display is typically wired directly into Pins 19, 20, and 21 of the 24-pin connector (J1), it can alternatively be plugged into J3 and unplugged when the programmer is used. Only Pins 2, 3, and 4 of J3 are needed for the display.

High Current Connections

Six round tin-plated brass studs are provided for the high current connections to the battery (**B+** and **B-**), the fuse (**F+**), and the three motor phases (**U**, **V**, **W**), located as shown in Figure 2.

The studs are threaded to accept M5 bolts. This simplifies the assembly and reduces the mounting hardware necessary for the power connections. Appropriate screws, washers, and cable lugs should be used to provide secure vibration-resistant connections on all power terminals.

The tightening torque applied to the bolts should not exceed 10 N·m (7.4 ft-lbs). Exceeding this limit could damage the studs' internal threads, resulting in loose connections.

WIRING: Standard Configuration A (no multiplexer)

Figure 3 shows the typical wiring configuration for applications where a tiller multiplexer is not used; these applications typically include an external main contactor.

For walkie applications the interlock switch is typically activated by the tiller, and an emergency reverse switch on the tiller handle provides the emergency reverse signal. **For rider applications** the interlock switch is typically a seatswitch or a footswitch, and there is no emergency reverse.

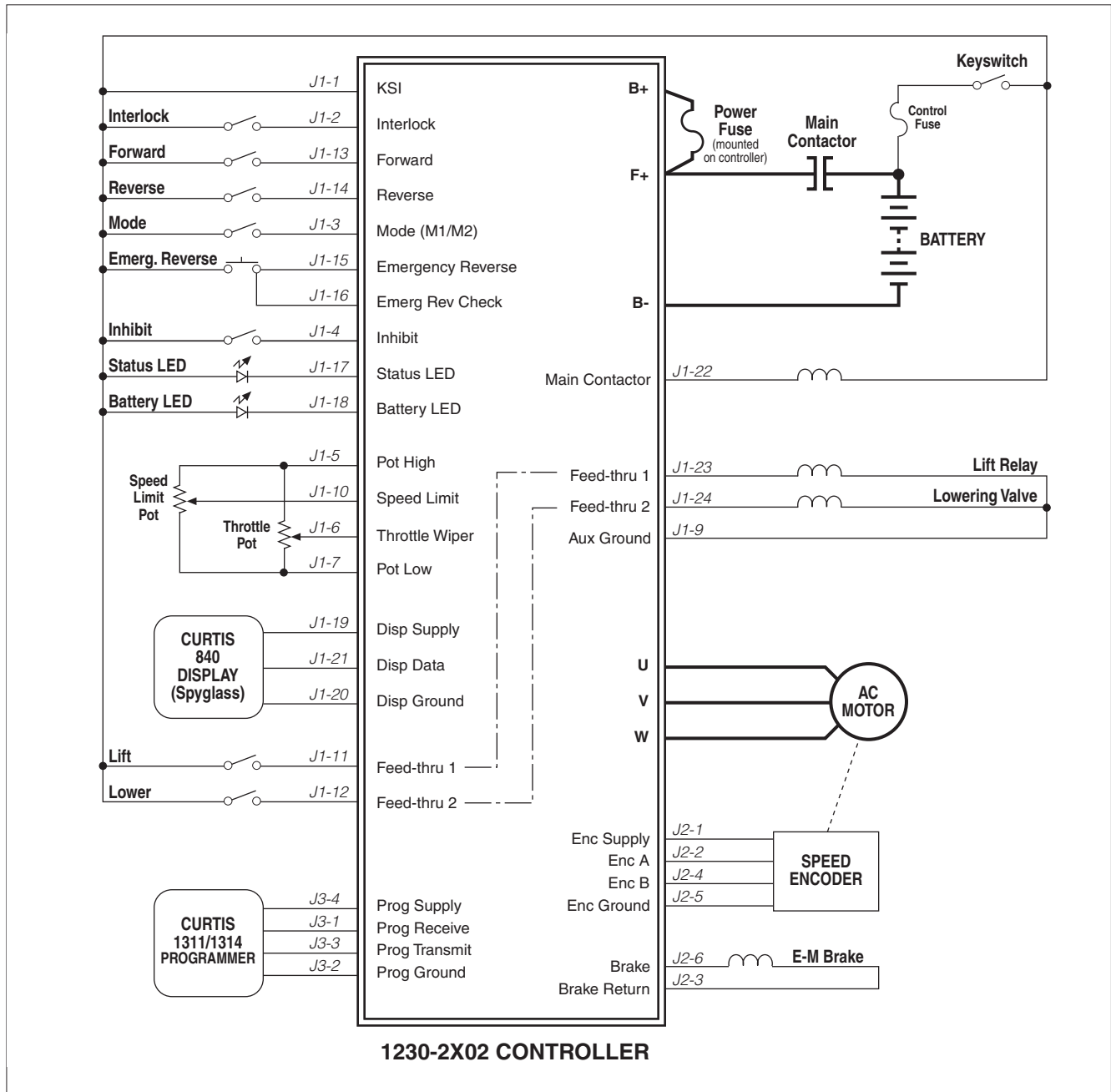

Fig. 3 Standard wiring configuration A: Curtis 1230-2X02 controller.



Power Wiring, Configuration A

Motor phase wiring is straightforward, with the motor's U, V, W phases connected directly to the controller's **U, V, W** studs. **CAUTION:** The sequence of the motor phase connections will affect the operation of the emergency reverse feature. The forward and reverse switches and the **U, V, W** connections must be configured so that the vehicle drives away from the operator when the emergency reverse button is pressed.

The negative battery terminal is always connected directly to the **B-** stud. The positive battery terminal is typically connected to the **F+** stud via the external main contactor, as shown in Figure 3. If the main fuse is not mounted on the controller, **F+** is not used and the positive battery terminal is connected to the **B+** stud.

If a main contactor is not required, the positive battery terminal can be connected directly to the **B+** or **F+** stud on the controller.

Standard Control Wiring, Configuration A

Wiring for the input switches and contactors is shown in Figure 3; the 24-pin connector is shown in more detail below.

24-pin detail (see Fig. 3):

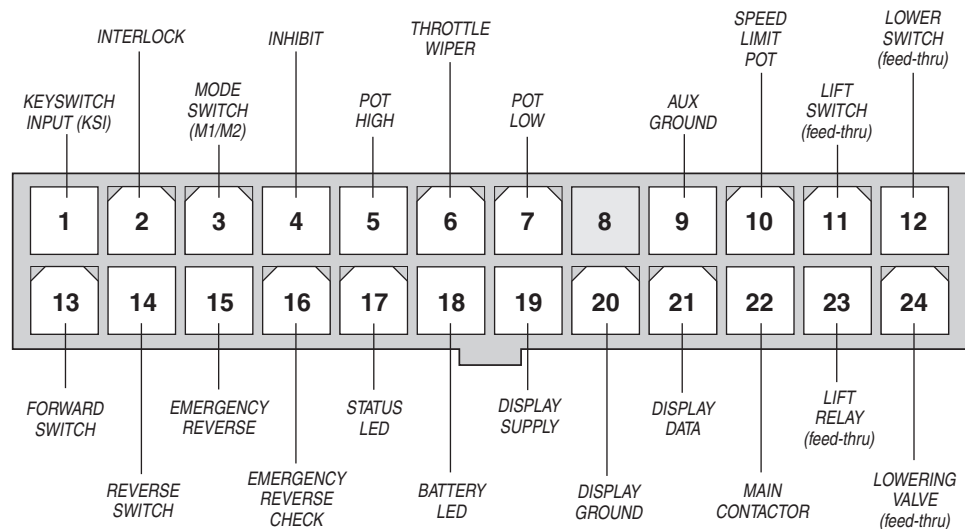

The main contactor coil must be wired directly to the controller as shown in Figure 3. The controller can be programmed to check for welded or missing contactor faults and uses the main contactor coil driver output to remove power from the controller and motors in the event of various other faults. **If the main contactor coil is not wired to J1 Pin 22, the controller will not be able to open the main contactor in serious fault conditions and the controller will not be protected against reverse battery polarity.**

Feed-throughs from J1 Pin 11 to Pin 23 and from J1 Pin 12 to Pin 24 are provided as a convenience, to simplify the wiring harness for lift/lower.

WIRING: Standard Configuration B (with multiplexer)

Figure 4 shows the typical wiring configuration for applications where a tiller multiplexer is used. Most 1230 models designed for use with a multiplexer include an internal main contactor (see specifications in Table C-1); for the 1230-2301 and -2401 models, which do not, the main contactor should be wired as shown in Figure 3.

With configuration B, there is no control of the lift/lower speed; the lift relay (at Pin 23) is a contactor that turns the pump motor on and off, and the lower valve output (at Pin 24) opens and shuts the lowering valve.

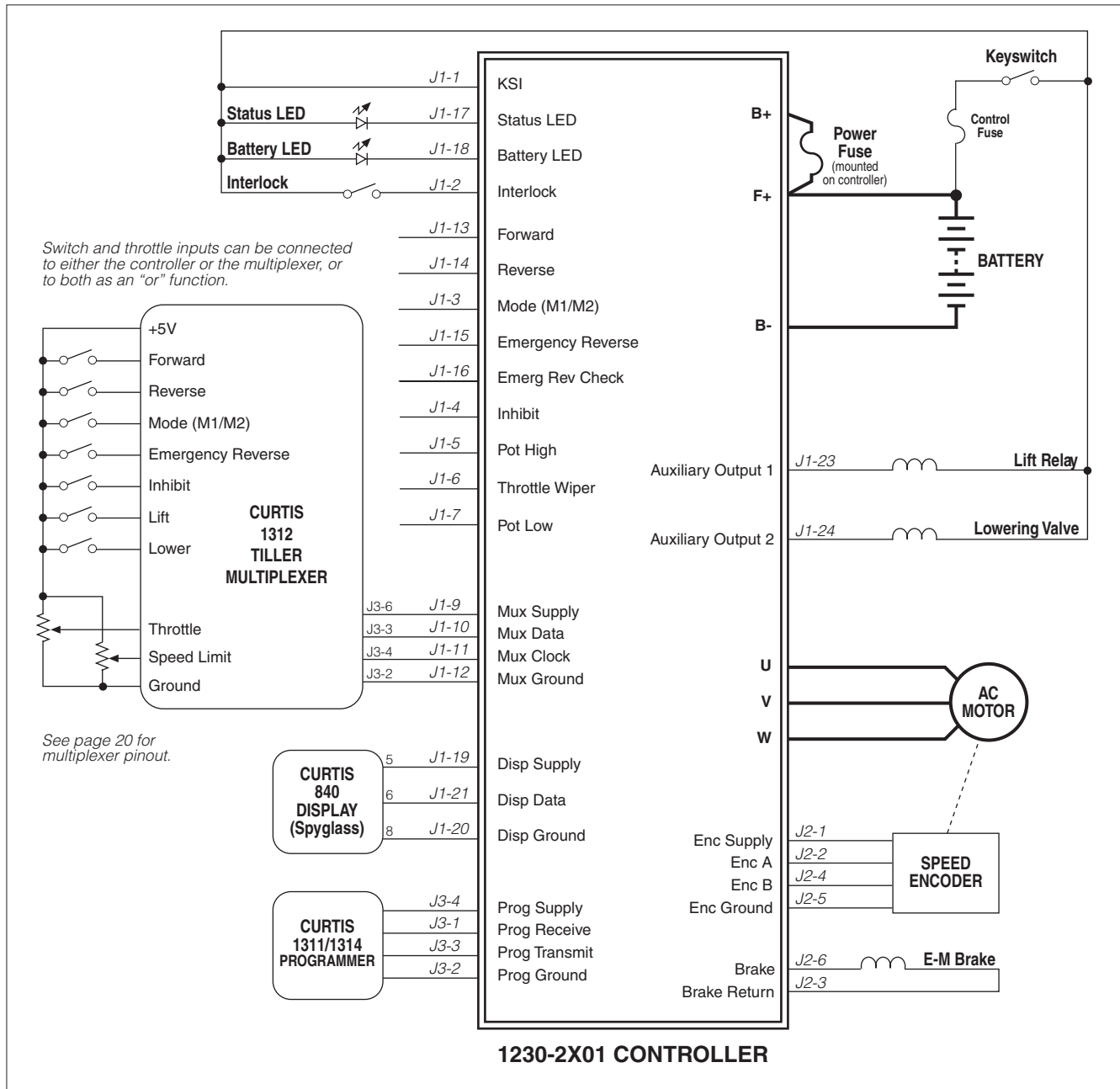

Fig. 4 Standard wiring configuration B: Curtis 1230-2X01 controller, in applications with a 1312 tiller multiplexer (but without a proportional valve).



Power Wiring, Configuration B

Motor phase wiring is straightforward, with the motor's U, V, W phases connected directly to the controller's **U, V, W** studs. **CAUTION:** The sequence of the motor phase connections will affect the operation of the emergency reverse feature. The forward and reverse switches and the **U, V, W** connections must be configured so that the vehicle drives away from the operator when the emergency reverse button is pressed.

The negative battery terminal is always connected directly to the **B-** stud. The positive battery terminal is typically connected to the **F+** stud, as shown in Figure 4. If the main fuse is not mounted on the controller, **F+** is not used and the positive battery terminal is connected to the **B+** stud.

Standard Control Wiring, Configuration B

Wiring for the input switches and contactors is shown in Figure 4; the 24-pin connector is shown in more detail below.

24-pin detail (see Fig. 4):

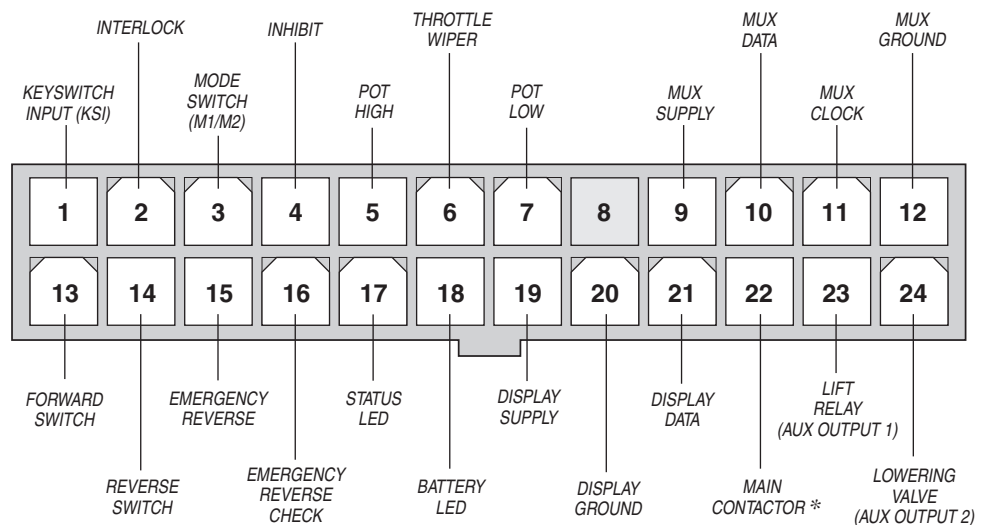

* Required for 1230-2301 and -2401 only.

The controller can be programmed to check for welded or missing contactor faults and uses the internal main contactor to remove power from the controller and motor in the event of various faults, including reversed battery polarity.

WIRING: Standard Configuration C (with multiplexer & PV)

Figure 5 shows the typical wiring configuration for applications where a proportional valve is used with the tiller multiplexer. Most 1230 models designed for use with a multiplexer include an internal main contactor (see specifications in Table C-1); for the 1230-2301 and -2401 models, which do not, the main contactor should be wired as shown in Figure 3. If there is a load hold valve, it needs to be controlled externally.

The proportional valve in configuration C is controlled by the hydraulic throttle in the multiplexer, providing variable speed lift/lower operation.

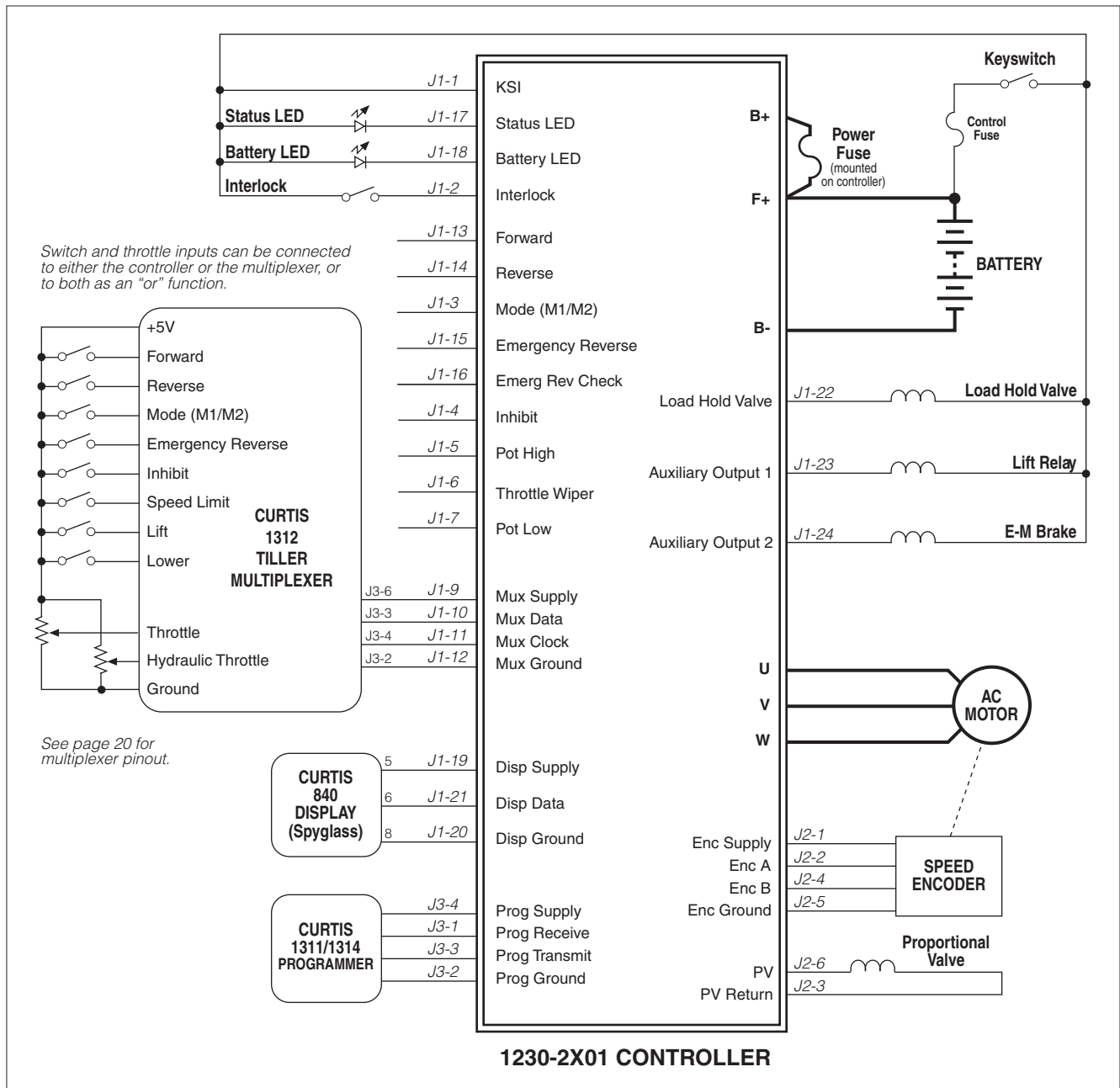

Fig. 5 Standard wiring configuration C: Curtis 1230-2X01 controller, in applications with a 1312 tiller multiplexer and a proportional valve on the hydraulic line.

Power Wiring, Configuration C



Motor phase wiring is straightforward, with the motor's U, V, W phases connected directly to the controller's **U, V, W** studs. **CAUTION:** The sequence of the motor phase connections will affect the operation of the emergency reverse feature. The forward and reverse switches and the **U, V, W** connections must be configured so that the vehicle drives away from the operator when the emergency reverse button is pressed.

The negative battery terminal is always connected directly to the **B-** stud. The positive battery terminal is typically connected to the **F+** stud, as shown in Figure 5. If the main fuse is not mounted on the controller, **F+** is not used and the positive battery terminal is connected to the **B+** stud.

Standard Control Wiring, Configuration C

Wiring for the input switches and contactors is shown in Figure 5; the 24-pin connector is shown in more detail below.

24-pin detail (see Fig. 5):

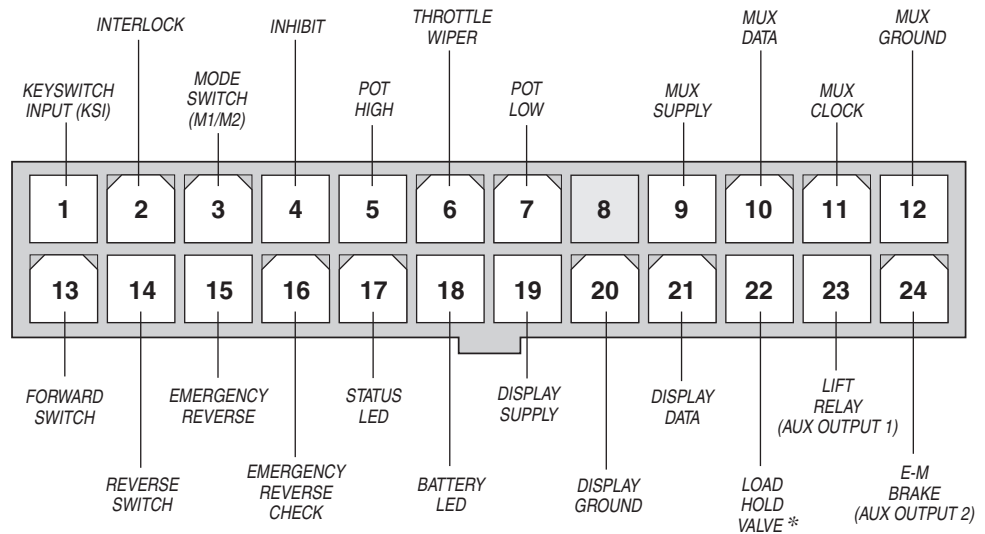

*Main contactor output for 1230-2301 and -2401; no Load Hold available for these models.

The controller can be programmed to check for welded or missing contactor faults and uses the internal main contactor to remove power from the controller and motor in the event of various faults, including reversed battery polarity.

The controller must be configured to control the proportional valve voltage by programming the Auxiliary Output Type parameter to 4, which assigns the PWM capability of J2 Pin 6 to the PV and the digital on/off output J1 Pin 24 to the electromagnetic brake. As the brake is no longer connected to J2 Pin 6 the Brake Fault Check parameter is moot and **brake fault checking is disabled**. The Brake Holding Voltage parameter is also moot, and the holding voltage is set at 100%.



WIRING: Throttles

Various throttles can be used with the 1230 controller. They are categorized as one of five types in the programming menu of the 13XX programmer. Only Types 2 and 4 can be used for the hydraulic throttle.

Type 1: two-wire 5k Ω –0 potentiometer throttles

Type 2: 0–5V, current source, and three-wire pot throttles—*wired for single-ended operation*

Type 3: two-wire 0–5k Ω potentiometer throttles

Type 4: 0–5V and three-wire pot throttles—*wired for wigwag operation*

Type 5: three-step switch throttles

Table 1 summarizes the operating specifications for the first four throttle types. For Type 5 throttles, see Table 2 on page 18. Note: For Type 2 and Type 4 throttles, the controller reads only voltage at the wiper input, even when potentiometers are used.

Table 1 THROTTLE WIPER INPUT THRESHOLD VALUES

| THROTTLE TYPE | PARAMETER | MINIMUM THROTTLE FAULT | THROTTLE DEADBAND (0% speed request) | THROTTLE MAX (100% modulation) | MAXIMUM THROTTLE FAULT |
|---------------|------------------|------------------------|--------------------------------------|--------------------------------|------------------------|
| 1 | Wiper Voltage | 5.00 V | 3.80 V | 0.20 V | 0.06 V |
| | Wiper Resistance | 7.50 k Ω | 5.50 k Ω | 0 k Ω | — |
| 2 | Wiper Voltage | 0.06 V | 0.20 V | 5.00 V | 5.30 V |
| | Wiper Resistance | — | — | — | — |
| 3 | Wiper Voltage | 0.06 V | 0.20 V | 3.80 V | 5.00 V |
| | Wiper Resistance | — | 0 k Ω | 5.50 k Ω | 7.50 k Ω |
| 4 | Wiper Voltage | 0.50 V | 2.50 V (Fwd) * 2.50 V (Rev) * | 4.40 V (Fwd) 0.60 V (Rev) | 4.50 V |
| | Wiper Resistance | — | — | — | — |

Notes: The upper and lower deadbands are valid for nominal 5k Ω potentiometers or 5V sources with the default Throttle Deadband and Throttle Max parameter settings of 0% and 100% respectively. These values will change with variations in the Throttle DB and Throttle Max parameter settings—see Section 3, pages 28 and 29.

* With 0% Throttle Deadband, there is no neutral point on a Type 4 pot. It is recommended that an 8% minimum deadband be used with Type 4 throttles.

For potentiometers, the 1230 provides complete throttle fault protection that meets all applicable EEC regulations. For voltage throttles, the 1230 protects against out-of-range wiper voltages (see Table 1), but does not detect wiring faults; it is therefore the responsibility of the OEM to provide full throttle fault protection in vehicles using voltage throttles.

Wiring for the most common throttles is described in the following text. If the throttle you are planning to use is not covered, contact the Curtis office nearest you.

5k Ω -0 Throttle (“Type 1”)

The 5k Ω -0 throttle (called a “Type 1” throttle in the programming menu of the 13XX programmer) is a 2-wire resistive throttle that connects between the pot wiper pin (Pin 6) and the Pot Low pin (Pin 7), as shown in Figure 6. For Type 1 devices, zero speed corresponds to a nominal 5 k Ω measured between the pot wiper and Pot Low pins and full speed corresponds to 0 Ω .

Fig. 6 Wiring for 5k Ω -0 throttle (“Type 1”).

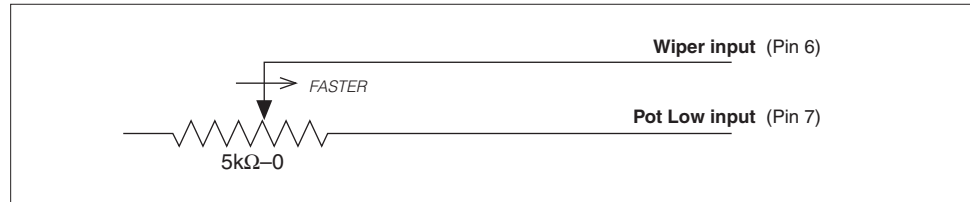

Broken wire protection is provided by the controller sensing the current flow from the wiper input (Pin 6) through the potentiometer and into the Pot Low pin (Pin 7). If the Pot Low input current falls below 0.65 mA or its voltage below 0.06 V, a throttle fault is generated and the throttle request is zeroed. Note: The Pot Low pin must not be tied to ground (B-).

Single-Ended 0-5V Voltage Source, Current Source, and 3-Wire Pot Throttles (“Type 2”)

With these throttles (“Type 2” in the programming menu) the controller looks for a voltage signal at the wiper input. Zero speed corresponds to 0 V and full speed to 5 V. A variety of devices can be used with this throttle input type, including voltage sources, current sources, and 3-wire pots. The wiring for each is slightly different and each has varying levels of throttle fault protection associated with it.

0-5V Throttle

Two ways of wiring the 0-5V throttle are shown in Figure 7. The active range for this throttle is from 0.2 V (at 0% Throttle Deadband) to 5.0 V (at 100% Throttle Max), measured relative to B-. It is the responsibility of the OEM to provide appropriate throttle fault detection for 0-5V throttles.

Fig. 7 Wiring for 0-5V throttles (“Type 2”).

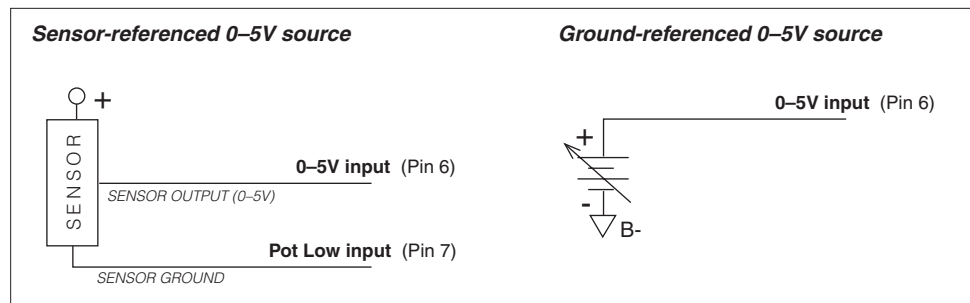

Sensor-referenced 0-5V throttles must provide a Pot Low current greater than 0.65 mA to prevent shutdown due to pot faults. It is recommended that

the maximum Pot Low current be limited to 55 mA to prevent damage to the Pot Low circuitry.

Ground-referenced 0–5V throttles require setting the Pot Low Check parameter (see Section 3, page 28) to Off; otherwise the controller will register a throttle fault. For ground-referenced 0–5V throttles, the controller will detect open breaks in the wiper input but cannot provide full throttle fault protection.

Also, the controller recognizes the voltage between the wiper input and B- as the applied throttle voltage and not the voltage from the voltage source relative to the Pot Low input.

For either throttle input, if the 0–5V throttle input (Pin 6) exceeds 5.5 V relative to B-, the controller will register a fault and shut down.

Current Source Used As a Speed Control Device

A current source can be used as a throttle input as shown in Figure 8. A resistor, R_{throttle} , must be used to convert the current source value to a voltage. The resistor should be sized to provide a 0–5V signal variation over the full current range.

Fig. 8 Wiring for current source throttle (“Type 2”).

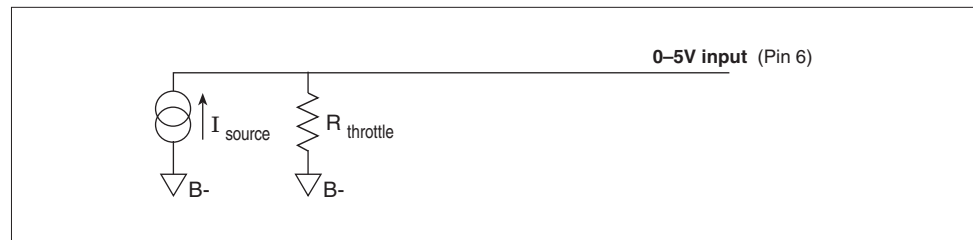

It is the responsibility of the OEM to provide appropriate throttle fault detection for current sources used as throttles.

3-Wire Pot Throttle (1–10 k Ω)

The 3-wire potentiometer is used in its voltage divider mode, with the voltage source and return being provided by the 1230 controller. Pot High provides a current limited 5 V source to the pot, and Pot Low provides the return path. Wiring is shown in Figure 9 and also in the three standard wiring diagrams, Figures 3, 4, and 5. Potentiometers with total resistance values between 1 k Ω and 10 k Ω can be used.

Fig. 9 Wiring for 3-wire potentiometer throttle (“Type 2”).

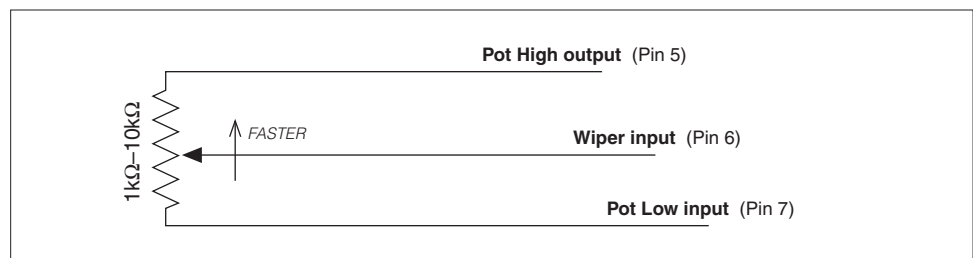

When a 3-wire pot is used and the Pot Low Check parameter (see Section 3, page 28) is set to On, the controller provides full fault protection in accordance with EEC requirements.

0–5k Ω Throttle (“Type 3”)

The 0–5k Ω throttle (“Type 3” in the programming menu) is a 2-wire resistive throttle that connects between the pot wiper pin and the Pot Low pin, as shown in Figure 10. Zero speed corresponds to 0 Ω measured between the two pins and full speed corresponds to 5 k Ω .

Fig. 10 Wiring for 0–5k Ω throttle (“Type 3”).

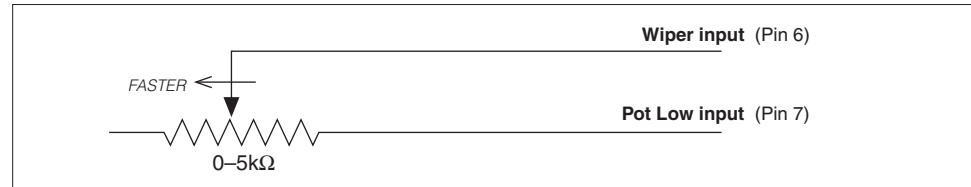

Broken wire protection is provided by the controller sensing the current flow from the wiper input through the potentiometer and into the Pot Low pin. If the Pot Low input current falls below 0.65 mA or its voltage below 0.06 V, a throttle fault is generated and the throttle request is zeroed. Note: The Pot Low pin must not be tied to ground (B-).

Wigwag-Style 0–5V Voltage Source and 3-Wire Pot Throttle (“Type 4”)

These throttles (“Type 4” in the programming menu) operate in true wigwag style. No signals to the controller’s forward and reverse (or lift and lower) inputs are required; the action is determined by the wiper input value. The interface to the controller for Type 4 devices is similar to that for Type 2 devices; see Figure 11 for wiring a wigwag 3-wire pot. The neutral point for Type 4 throttles is with the wiper at 2.5 V, measured between Pot Low (Pin 6) and B-.

Fig. 11 Wiring for wigwag 3-wire potentiometer throttle (“Type 4”).

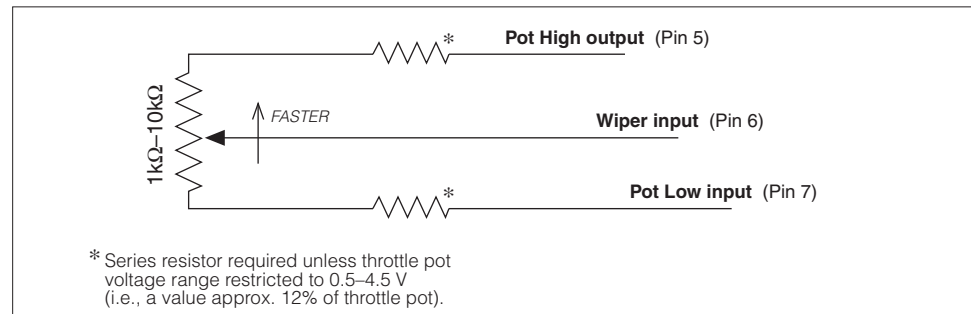

For the traction throttle, the controller will provide increasing forward speed as its wiper input value (Pin 4) is increased above the neutral point, and increasing reverse speed as the wiper input value is decreased below the neutral point. For the hydraulic throttle, the controller will provide increasing Lift speed as its wiper input value (Pin 21) is increased above neutral, and increasing Lower speed as the wiper input value is decreased below neutral. The minimum and maximum wiper voltage for either throttle must not exceed the 0.5V and 4.5V fault limits.

When a 3-wire pot is used and the Pot Low Check parameter (see Section 3, page 28) is set to On, the controller provides full fault protection for Type 4 traction throttles. Any potentiometer value between 1 k Ω and 10 k Ω is supported. When a voltage throttle is used, it is the responsibility of the OEM

to provide appropriate throttle fault detection. Note: If your Type 4 throttle has an internal neutral switch, this internal neutral switch should be wired to the forward switch input (Pin 13). The controller will behave as though no throttle is requested when the neutral switch is high, and will use the throttle value when the neutral switch is low.

Three-Step Switch Throttle (“Type 5”)

The three-step switch throttle (“Type 5” in the programming menu) replaces the proportional throttle with two switches—Speed 1 and Speed 2—that select between three discrete speeds. The Speed 1 switch is connected to the throttle wiper input and the Speed 2 switch to the speed limit input.

The Throttle Deadband, Throttle Map, and Throttle Max parameters are used to define the three discrete speeds. The speed is determined by the combination of Speed 1 and Speed 2 switches, as shown in Table 2. These three speeds apply in both forward and reverse.

| SPEED 1 SWITCH (Pin 6) | SPEED 2 SWITCH (Pin 10) | SPEED IS DEFINED BY THE VALUE SET FOR THIS PARAMETER |
|------------------------|-------------------------|--|
| Open | Open | Throttle Deadband |
| Closed | Open | Throttle Map |
| — | Closed | Throttle Max |

WIRING: Auxiliary Drivers (1230-2x01 MODELS ONLY)

Two auxiliary drivers are provided at Pins 23 and 24. These low side drivers, depending on how they are programmed (see page 43), can be used for a variety of functions. Output is rated at 2 amps. An active clamping circuit at 70 V provides fast turn-off and protects the drivers from inductive voltage kickback spikes. These outputs are designed to drive solenoids or relays. However, they can be used to drive any load requiring up to 2 amps maximum current.

WIRING: Emergency Reverse

To implement the emergency reverse feature, the emergency reverse input (J1 Pin 15) must be connected to battery voltage. The emergency reverse input can be configured to accept normally open or normally closed switches.

Emergency reverse is activated when the vehicle is moving forward and the emergency reverse switch is pressed. After the emergency reverse switch is released, normal controller operation is not resumed until neutral (no direction) is selected or until the interlock switch is cycled. The recommended wiring is shown in Figures 3–5. The controller decelerates at the programmed fast stop rate as soon as the emergency reverse switch closes. The vehicle will then be

automatically driven in the reverse direction at the programmed emergency reverse acceleration rate and speed until the emergency reverse switch is released or the emergency reverse time limit is reached.



CAUTION: The sequence of the motor phase connections will affect the operation of the emergency reverse feature. The forward and reverse switches and the **U, V, W** connections must be configured so that the vehicle drives away from the operator when the emergency reverse button is pressed.

WIRING: Emergency Reverse Check

A wire connected directly to the emergency reverse switch provides for broken wire detection when that feature is programmed On (see Section 3, page 33). The emergency reverse check output wire periodically pulses the emergency reverse circuit to check for continuity in the wiring. If there is no continuity, the controller output is inhibited until the wiring fault is corrected.

If the option is selected and the check wire is not connected, the vehicle will not operate. If the option is not selected and the check wire is connected, no harm will occur—but continuity will not be checked.

Emergency reverse checking is disabled if the emergency reverse input is configured to accept normally closed switches.

WIRING: Spyglass Display

The Curtis 840 Spyglass features an 8-character LCD display that sequences between hourmeter, BDI, and fault messages. Depending on the model, either three or six indicator LEDs are also located on the face of the gauge. The mating 8-pin connector is Molex 39-01-2085, with 39-00-0039 (18–24 AWG) pins.

Fig. 12 Wiring guide and mounting dimensions for Curtis 840 Spyglass display.

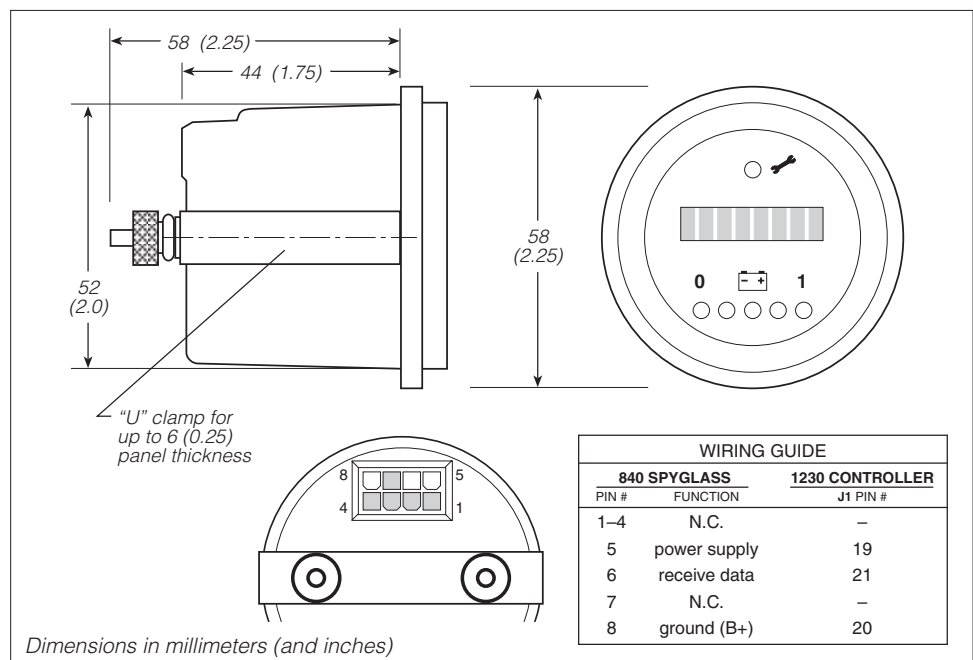

WIRING: Tiller Multiplexer

The Curtis 1312 Multiplexer provides monitoring and control capability for up to 12 analog or digital signals from operator controls on the tiller. Each signal is sampled every 20 milliseconds for fast response.

The mating 6-pin connector is Molex 39-01-2065 and the mating 24-pin connector is Molex 39-01-2245, both with 39-00-0039 (18–24 AWG) pins.

Fig. 13 Wiring guide and mounting dimensions for Curtis 1312 Multiplexer.

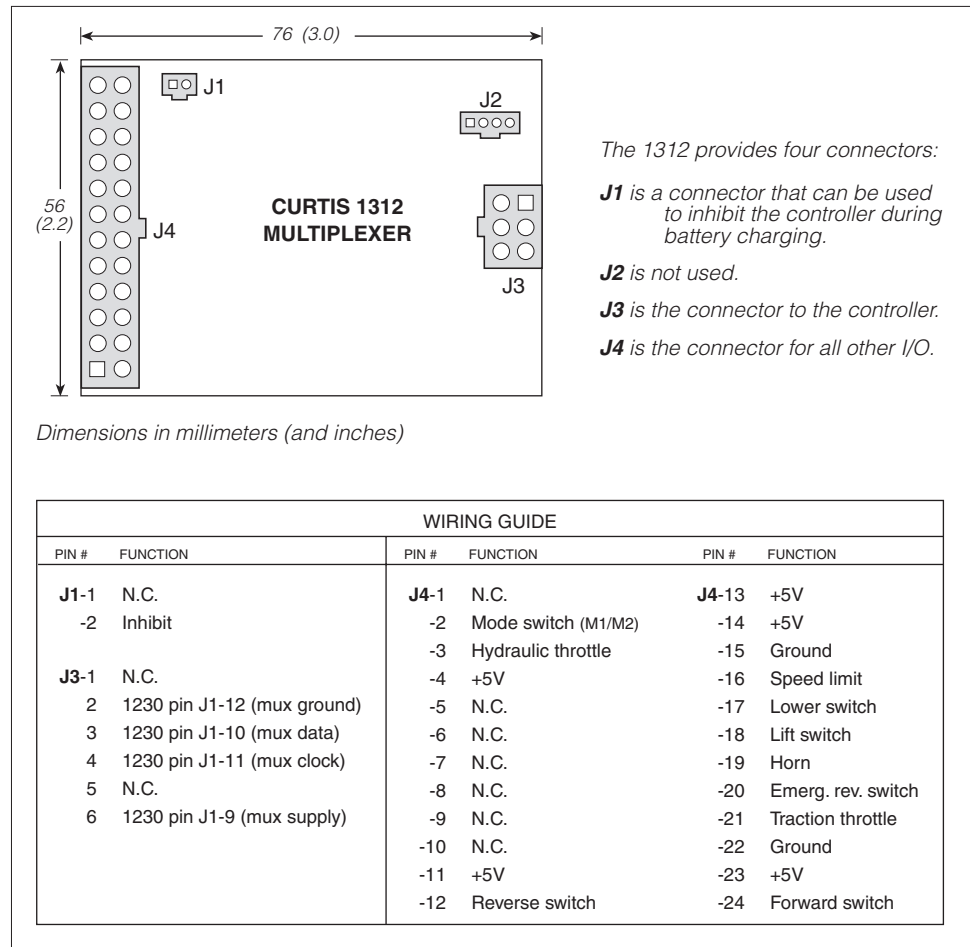

CONTACTOR, SWITCHES, and OTHER HARDWARE

Speed Encoder

A quadrature speed encoder for rotor speed measurement is required to ensure precise speed control of the AC motor. The controller provides power supply and ground reference lines as well as A and B signal inputs with internal pull-up resistors. Encoder resolution can range from 2 to 200 pulses per revolution.

The encoder inputs are designed to work with open-collector output quadrature encoders such as SKF sensorized bearings. If you intend to use a different type of encoder or sensors please contact your local Curtis office.

Main Contactor

1230-2002, -2102, -2202, -23xx, and -24xx models

An external main contactor should be used with these models. The contactor allows the controller and motor to be disconnected from the battery. This provides a significant safety feature, because it means battery power can be removed if a controller or wiring fault results in battery power being applied to the motor inappropriately.

A single-pole, single-throw (SPST) contactor with silver-alloy contacts, such as an Albright SW180 or SW200 (available from Curtis), is recommended for use as the main contactor. The contactor coils should be specified with a continuous rating at the nominal battery pack voltage.

The 1230 controller provides a low-side contactor coil driver (at J1 Pin 22) for the contactor. The driver output is rated at 2 amps. An active clamping circuit at 70 V provides fast turn-off and protects the driver from inductive voltage kickback spikes.

The main contactor coil must be wired directly to the controller as shown in Figure 4. The controller can be programmed to check for welded or missing contactor faults and will use the main contactor coil driver output to remove power from the controller and motor in the event of various other faults. **If the main contactor coil is not wired to J1 Pin 22, the controller will not be able to open the main contactor in serious fault conditions and the controller will not be protected against reverse battery polarity.**



1230-2001, -2101, and -2201 models

These models have an internal main contactor and therefore J1 Pin 22 is not used; the internal main contactor provides all the protection features described above.

Keyswitch

The vehicle should have a master on/off switch to turn the system off when not in use. The keyswitch input provides logic power for the controller. The keyswitch provides current to drive the main contactor, electromagnetic brake, and valve solenoid coils and must be rated to carry these currents.

Interlock, Forward/Reverse, Mode, Emergency Reverse, Inhibit, and Auxiliary Input Switches

These input switches can be any type of single-pole, single-throw (SPST) switch capable of switching the battery voltage at 10 mA.

The interlock switch—which is typically implemented as a tiller switch, deadman footswitch, or seatswitch—provides a safety interlock for the system.

Typically the Emergency Reverse switch is a momentary switch, active only while it is being depressed.

The emergency reverse and inhibit inputs can be configured independently to accept normally open or normally closed switches.

Electromagnetic Brake

The electromagnetic brake, which is usually mounted to the motor shaft, is mechanically engaged by a spring force and electrically released. In wiring configurations A and B, the brake is connected to J2 Pins 3 and 6. The PWM low-side driver at Pin 6 is rated at 2 amps and is monitored for overcurrent faults. In wiring configuration C, the brake is connected to the digital on/off output at J1 Pin 24; in this configuration, there is no brake fault checking.

Valves

The hydraulic line's load holding valve (if used) and lowering valve or proportional valve (whichever is used) should be large enough to provide adequate flow when open. The load holding valve's solenoid coil should be rated at the nominal battery voltage of the system and must not exceed the 2 amp rating of its driver. The lowering or proportional valve solenoid coil should be rated at or below the nominal battery voltage and should be capable of opening the valve completely using not less than 0.25 amp and not more than 2 amps.

Speed Limit Input

As shown in wiring configurations A and B (pages 8 and 10), a potentiometer can be used to limit speed; alternatively, a switch can be used, as shown in configuration C (page 12). The Speed Limit Type parameter configures the speed limit input. The Min Speed parameter sets the maximum speed at full throttle when the speed pot wiper is shorted to the Pot Low connection (Pin 7), or the speed limit switch is in the Min Speed position. The Max Speed parameter sets the maximum speed at full throttle when the wiper is shorted to Pot High (Pin 5), or the switch is in the Max Speed position.

Battery LED and Status LED Outputs

The 1230 has two signal outputs (J1 Pins 17 and 18) that can be used to provide diagnostic battery and controller status information. These outputs provide low side drivers that pull to B- when active. They are rated at 10 mA and are designed to light indicator LEDs integrated into a display panel. However, they can be used to drive any load requiring less than 10 mA of drive current.

Circuitry Protection Devices

To protect the control circuitry from accidental shorts, a low current fuse (appropriate for the maximum current draw) should be connected in series with the battery feed to the keyswitch. Additionally, a high current fuse should be wired in series with the main contactor to protect the motor, controller, and batteries from accidental shorts in the power system; this fuse can be mounted directly on the controller. The appropriate fuse for each application should be selected with the help of a reputable fuse manufacturer or dealer. The standard wiring diagrams (Figures 3–5) show the recommended location for each fuse.

3

PROGRAMMABLE PARAMETERS

The 1230 controller has a number of parameters that can be programmed using a Curtis 1311 handheld programmer or 1314 PC programming station. These programmable parameters allow the vehicle's performance to be customized to fit the needs of individual vehicles or vehicle applications. For information on programmer operation, see Appendix B.

PROGRAMMING MENUS (for setting the programmable parameters)

The programmable parameters are grouped into three main categories (vehicle, motor & control, system), and into additional subgroups, each with its own programming menu.

VEHICLE PARAMETER GROUP

- Rate
- Speed
- Multimode
- Throttle
- Sequencing
- Brake
- Emergency Reverse

MOTOR & CONTROL PARAMETER GROUP

- Motor
- Control

SYSTEM PARAMETER GROUP

- Battery
- Hourmeter
- Hydraulic
- Other

A complete list of the individual parameters is presented on the next page. The parameters are described in the charts that follow. For each parameter, the charts provide:

- parameter name as it appears in the programmer display,
- allowable range,
- description of the parameter's function and, where applicable, suggestions for setting it.

We urge you to read Section 5, Initial Setup, before adjusting any of the parameters.

Even if you opt to leave most of the parameters at their default settings, **it is imperative that you perform the procedures outlined in Section 5, which set up the basic system characteristics for your application.**

VEHICLE GROUP

Rate Parameters

- Accel Rate, M1–M2
- Decel Rate, M1–M2
- Brake Rate, M1–M2
- Fast Stop Rate
- Accel Release Rate

Speed Parameters

- Min Speed, M1–M2
- Max Speed, M1–M2
- Speed Limit Type

MultiMode Parameters

- Mode Select Type
- Coast Decel Rate
- Anti-Tiedown

Throttle Parameters

- Throttle Type
- Throttle Deadband
- Throttle Max
- Throttle Map
- Pot Low Check

Sequencing Parameters

- Interlock Normally Open
- Sequencing Delay
- Static Return to Off (SRO)
- High Pedal Disable (HPD)
- Main Cont Interlock Type
- Main Cont Open Delay
- Main Contactor Check

Brake Parameters

- Brake Fault Check
- Brake Delay
- Brake Hold Voltage
- Brake Driver Type
- Anti-Rollback Time

Emergency Reverse Parameters

- Wiring Check
- Speed
- Direction Interlock
- Time Limit
- Accel Rate
- Switch Closed

MOTOR & CONTROL GROUP

Motor Parameters

- Min Motor Voltage
- Nominal Motor Voltage
- Nominal Motor Frequency
- Max Motor Speed
- Number of Motor Poles
- Encoder Pulses/Revolution
- Swap Encoder Direction
- Failsafe Delay

Control Parameters

- P Gain
- I Gain
- Accel Slip
- Regen Slip
- Slip Boost
- Pull-Out Slip
- Accel Slip Voltage
- Regen Slip Voltage
- Accel Comp
- Regen Comp
- Regen Voltage Offset

SYSTEM GROUP

Battery Parameters

- Full Voltage
- Empty Voltage
- BDI Reset Battery Voltage
- Battery Recharge Level
- Low Voltage Level

Hourmeter Parameters

- Enable Total Service Hours
- Enable Drive Service Hours
- Adjust Hours
- Set Total Hours
- Set Drive Hours
- Total Service Hours
- Drive Service Hours
- Total Disable Hours
- Drive Disable Hours
- Drive Disable Speed
- Service Total Expired
- Service Drive Expired
- Maximum Regen Flux

Hydraulics Parameters *

- Lift PV Max
- Lift PV Min
- Lift PV Accel Rate
- Lift PV Decel Rate
- Lower PV Max
- Lower PV Min
- Lower PV Accel Rate
- Lower PV Decel Rate
- PV Dither
- Pump Start Delay
- Pump BDI Lockout
- Lift PV Hold Delay
- Load Hold Delay
- Open Hold Load During Lift
- Hyd Throttle Type
- Hyd Throttle Deadband
- Hyd Throttle Max
- Hyd Throttle Map
- Max Pump Run Time

Other System Parameters

- Power Save Delay
- Mux Inputs Enabled *
- Inhibit Input Type
- Auxiliary Output Type *
- Fault Code

*1230-2xx1 models only.

| RATE MENU | | |
|---------------------------|-----------------|--|
| PARAMETER | ALLOWABLE RANGE | DESCRIPTION |
| M1–M2 Accel Rate | 0.1–5.0 sec. | <p>Defines the time it takes the controller to accelerate from 0% output to 100% output when full throttle is requested. Larger values represent a longer acceleration time and a gentler start. Fast starts can be achieved by reducing the acceleration time, i.e., but setting the Accel Rate to a smaller value.</p> |
| M1–M2 Decel Rate | 0.1–10.0 sec. | <p>Defines the time it takes the controller to decelerate from 100% output to 0% output. The Decel Rate determines the vehicle's braking characteristic for any reduction in throttle that does not include a request for the opposite direction. Lower values represent faster deceleration and thus a shorter stopping distance.</p> <p>The Decel Rate should be set to a higher value (slower deceleration) than the corresponding Brake Rate.</p> |
| M1–M2 Brake Rate | 0.1–5.0 sec. | <p>Defines the time it takes the controller to brake from 100% output to 0% output when a new direction is selected. Larger values represent a longer time and consequently gentler braking. Faster braking can be achieved by adjusting the braking rate to a smaller value.</p> <p>The Brake Rate should be set to a lower value (faster deceleration) than the corresponding Decel Rate.</p> |
| Fast Stop Rate | 0.1–5.0 sec. | <p>Defines the time it takes the controller to stop from full speed when a fast stop is required, either because the interlock switch has opened or because the emergency reverse switch has been pressed.</p> |
| Accel Release Rate | 0.0–1.0 sec. | <p>Defines how quickly deceleration will be initiated when the throttle is released while the vehicle is still accelerating. If the release rate is fast (i.e., set to a low value), the transition is initiated abruptly. The transition is smoother if the release rate is set to a higher value (slower transition); however, setting the rate to too high a value can cause the vehicle to feel uncontrollable when the throttle is released, as it will continue to drive for a short time.</p> |

| SPEED MENU | | |
|-------------------------|-----------------|--|
| PARAMETER | ALLOWABLE RANGE | DESCRIPTION |
| M1-M2 Min Speed | 0-50 % | Defines the controller output at full throttle when the speed limit pot is in its lowest position or the speed limit switch is calling for minimum speed. |
| M1-M2 Max Speed | 5-100 % | Defines the controller output at full throttle when the speed limit pot is in its highest position or the speed limit switch is calling for maximum speed. |
| Speed Limit Type | 0-3 | <p>Configures the speed limit input to work with a speed limit pot (analog input) or with a switch (either normally open or normally closed).</p> <p>0 = no speed limit; speed limit input is ignored.</p> <p>1 = linear speed limit (speed limit pot) <i>programmed max speed when speed limit input voltage = 5.0 V</i> <i>programmed min speed when speed limit input voltage = 0.2 V</i></p> <p>2 = normally open switch <i>programmed max speed when speed limit switch is open</i> <i>programmed min speed when speed limit switch is closed</i></p> <p>3 = normally closed switch <i>programmed max speed when speed limit switch is closed</i> <i>programmed min speed when speed limit switch is open</i></p> |

| MULTIMODE MENU | | |
|-------------------------|-----------------|--|
| PARAMETER | ALLOWABLE RANGE | DESCRIPTION |
| Mode Select Type | 0–3 | <p>Configures mode switch operation.</p> <p>0 = Standard M1/M2 MultiMode operation. <i>When the mode switch is open, the programmed M1 parameter settings for Accel Rate, Decel Rate, Brake Rate, Min Speed, and Max Speed are in effect; when the mode switch is closed, the programmed M2 parameter settings are in effect.</i></p> <p>1 = Creep <i>Same as 0, except when the vehicle is operating in Mode 2, the interlock switch input is ignored.</i></p> <p>2 = Coast <i>Same as 0, except when the vehicle is operating in Mode 1, the Coast Deceleration Rate is in effect when the throttle is reduced or released. (When the opposite direction is selected, the M1 Brake Rate is in effect.)</i></p> <p>3 = Secure Creep <i>Same as 0, except that the transition from Mode 2 to Mode 1 is only possible when interlock is Off or throttle input is 0.</i></p> |
| Coast Decel Rate | 0.1–20.0 sec. | <p>Defines how quickly the controller reduces its output to zero when the throttle is released. This parameter allows adjustment for different sized vehicles. Lower values represent faster deceleration and thus a shorter coasting distance. The Coast Decel Rate only applies when the Mode Select Type is set to Type 2 and the vehicle is operating in Mode 1.</p> |
| Anti-Tiedown | OFF/ON | <p>The anti-tiedown feature prevents operators from taping or “tying down” the mode switch in order to operate permanently in Mode 2, which is typically the high speed mode. Upon startup, when the interlock switch is first closed, the controller will ignore the request and default to Mode 1. The controller will remain in Mode 1 until the mode switch is released and reactivated.</p> <p>For safety, anti-tiedown should be used only when Mode 2 is faster than Mode 1.</p> |

| THROTTLE MENU | | |
|--------------------------|-----------------|---|
| PARAMETER | ALLOWABLE RANGE | DESCRIPTION |
| Throttle Type | 1–5 | <p>The 1230 controller accepts a variety of throttle inputs; see throttle wiring section, pages 14–18. The throttle type parameter can be programmed as follows:</p> <ol style="list-style-type: none"> 1 2-wire rheostat, 5kΩ–0 input 2 <u>single-ended</u> 3-wire 1kΩ–10kΩ potentiometer, 0–5V voltage source, or current source 3 2-wire rheostat, 0–5kΩ input 4 <u>wigwag</u> 3-wire 1kΩ–10kΩ potentiometer, or 0–5V voltage source 5 three-step switch throttle (Note: with a Type 5 throttle, the remaining throttle parameters do not apply.) |
| Throttle Deadband | 0–30 % | <p>Defines the throttle pot wiper voltage range that the controller interprets as neutral. This parameter is especially useful with throttle assemblies that do not reliably return to a well-defined neutral point, because it allows the deadband to be defined wide enough to ensure that the controller goes into neutral when the throttle mechanism is released. See Figure 14.</p> <p>The throttle deadband is adjustable from 0% to 30% of the nominal throttle wiper range; it is typically set at 10%. The nominal throttle wiper voltage range depends on the throttle type selected; see Table 1.</p> |
| Throttle Max | 40–100 % | <p>Defines the wiper voltage or resistance required to produce 100% controller output. Decreasing the throttle max setting reduces the wiper voltage or resistance and therefore the full stroke necessary to produce full controller output. This parameter allows reduced-range throttle assemblies to be accommodated. See Figure 14.</p> <p>The throttle max is set as a percentage of the nominal throttle wiper voltage range, which depends on the throttle type selected; see Table 1.</p> |
| Throttle Map | 5–90 % | <p>Modifies the vehicle's response to the throttle input. Setting the throttle map at 50% provides a linear output response to throttle position. Values below 50% reduce the controller output at low throttle settings, providing enhanced slow speed maneuverability. Values above 50% give the vehicle a faster, more responsive feel at low throttle settings. See Fig. 14.</p> <p>The value is set as a percentage of the throttle's full active range, which is the voltage or resistance between the programmed throttle deadband value and the programmed throttle max value.</p> |
| Pot Low Check | OFF/ON | <p>The pot low check, when programmed On, checks the voltage at the wiper input (J1 Pin 6) and faults the controller if this voltage drops below 0.06 V. It is recommended that the pot low check feature be programmed On in any application where a resistive throttle is used. This will provide maximum throttle fault detection and provide the safest possible vehicle operation. However, disabling the feature is useful when single-wire ground-referenced voltage throttle inputs are used.</p> <p>For Throttle Type 4, when pot low check is programmed Off the automatic pot high check is also disabled. This allows the use of wigwag throttles without series resistors.</p> |

All three throttle adjustment parameters—Deadband, Max, Map—condition the raw throttle voltage into a single % throttle command, as shown in Figure 14.

Fig. 14 *Effect of throttle adjustment parameters. Together these three parameters determine the controller's response to throttle demand.*

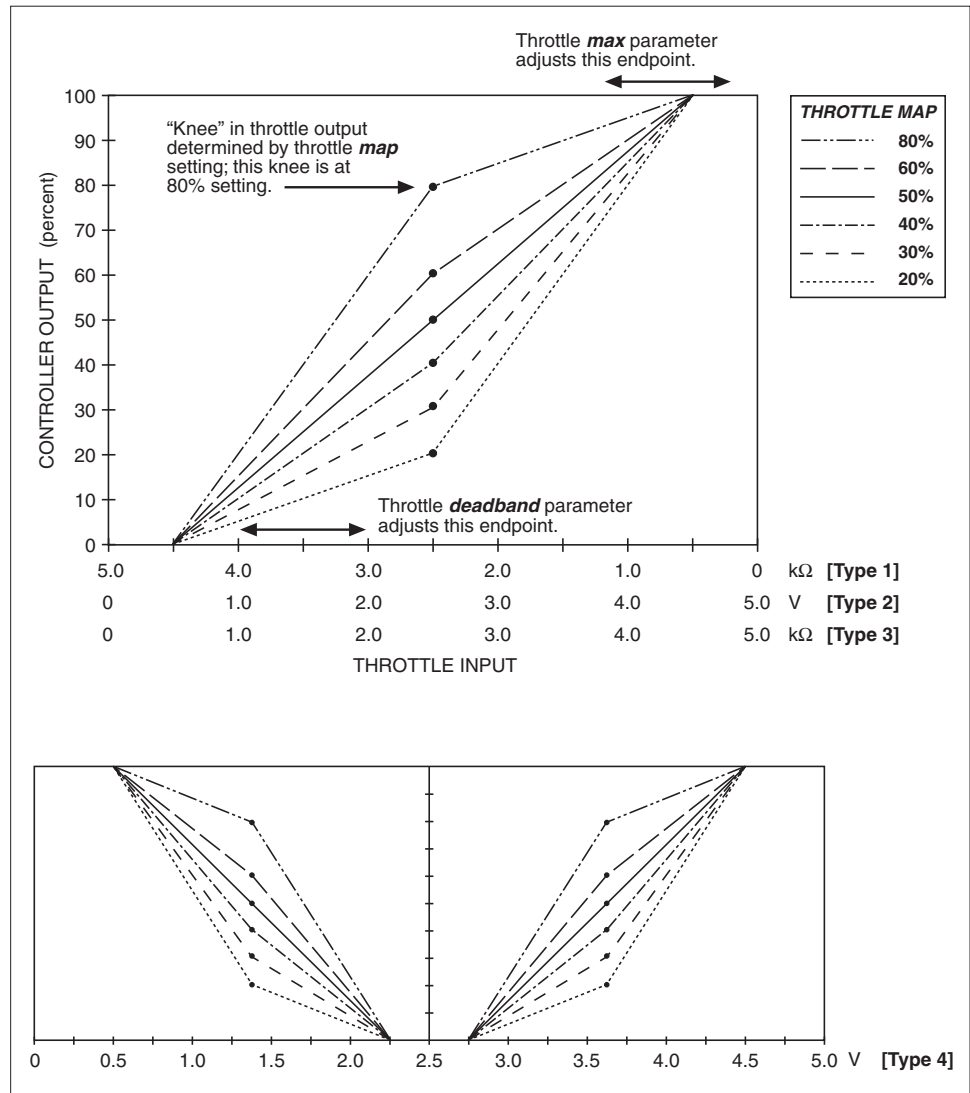

| SEQUENCING MENU | | |
|-----------------------------------|-----------------|--|
| PARAMETER | ALLOWABLE RANGE | DESCRIPTION |
| Interlock Normally Open | OFF/ON | When a normally-open type of interlock switch is used, this parameter must be programmed On. |
| Sequencing Delay | 0.0–3.0 sec. | The sequencing delay feature allows the interlock switch to be cycled within a set time (the sequencing delay), thus preventing inadvertent activation of HPD and SRO. This feature is especially useful in applications where the interlock switch may bounce or be momentarily cycled during operation. When set to 0.0, there is no delay. |
| Static Return To Off (SRO) | 0–3 | <p>The SRO feature prevents the vehicle from being started when “in gear.” SRO checks the sequencing of the interlock input—or the interlock input and KSI—relative to a direction input. If a direction is selected before or simultaneously (within 50 msec) with the interlock input, controller output is inhibited. SRO faults can result from using an incorrect sequence, or from using a correct sequence with less than 50 msec between steps. Three types of SRO are available, along with a “no SRO” option:</p> <p>0 = no SRO</p> <p>1 = SRO unless interlock input before a direction input</p> <p>2 = SRO unless KSI before interlock input before a direction input</p> <p>3 = SRO unless KSI before interlock input before a <u>forward</u> direction input</p> <p>If you select SRO Type 2, the following sequence must be followed to enable the controller: STEP 1, turn on KSI; STEP 2, activate interlock; then STEP 3, select a direction. The interval between steps 1 and 2 is the same as between steps 2 and 3; that is, KSI input must precede interlock input by at least 50 msec. Once the controller is operational, turning off either KSI or the interlock causes the controller to inhibit its output; re-enabling the controller requires the 3-step sequence.</p> <p>Similarly, if your controller is programmed so that KSI, interlock, and <u>forward</u> inputs are all required (SRO Type 3), they must be provided in that sequence in order to enable the controller. Note, however, that operation is allowed if a <u>reverse</u> input precedes the interlock input; this can be useful when operating a walkie on ramps.</p> <p>Sequencing delay (above) can be used to provide a brief delay before SRO inhibits controller output, if desired.</p> |
| High Pedal Disable (HPD) | 0–2 | <p>HPD prevents the vehicle from being started if the controller is turned on with the throttle applied. In addition to providing routine smooth starts, HPD also protects against accidental sudden starts if problems in the throttle linkage (e.g., bent parts, broken return spring) give a throttle input signal to the controller even with the throttle released.</p> <p>If the operator attempts to start the vehicle with the throttle already applied, the controller will inhibit output to the motor until the throttle input is reduced to zero. For the vehicle to run, the controller must receive a KSI input—or KSI and interlock inputs—before receiving a throttle input greater than zero.</p> |

| SEQUENCING MENU, cont'd | | |
|---|-----------------|---|
| PARAMETER | ALLOWABLE RANGE | DESCRIPTION |
| High Pedal Disable (HPD) , <i>cont'd</i> | | <p>To meet EEC requirements, HPD Type 1 or Type 2 must be selected. Sequencing delay (above) can be used to provide a brief delay before HPD inhibits controller output, if desired.</p> <p>Two types of HPD are available, along with a “no HPD” option:</p> <p>0 = no HPD</p> <p>1 = Interlock-type HPD <i>To start the vehicle, the controller must receive both an interlock input and a KSI input before receiving a throttle input. Controller operation will be disabled if throttle demand is not zero at the time the interlock switch is closed. Normal operation is regained by reducing the throttle demand to zero.</i></p> <p>2 = KSI-type HPD <i>To start the vehicle, the controller must receive a KSI input before receiving a throttle input. Controller operation will be disabled if throttle demand is not zero at the time KSI is enabled. In this configuration, if throttle is applied before the interlock switch is closed but after the KSI input has been enabled, the vehicle will accelerate to the requested speed as soon as the interlock switch is closed.</i></p> |
| Main Contactor Interlock Type | 0–1 | <p>Two types of interlock are available for the main contactor:</p> <p>0 = main contactor closes upon interlock plus throttle <i>The main contactor closes when the interlock switch closes and throttle is applied. The Main Contactor Open Delay (below) starts counting as soon as the interlock switch is opened.</i></p> <p>1 = main contactor closes upon interlock <i>The main contactor closes when the interlock switch closes, regardless of throttle demand. The Main Contactor Open Delay (below) starts counting as soon as the interlock switch is opened.</i></p> |
| Main Contactor Open Delay | 0–60 sec. | <p>The delay can be set to allow the main contactor to remain closed for a period of time (the programmed delay) after the motor has stopped. The delay is useful for preventing unnecessary cycling of the contactor and for maintaining power to auxiliary functions that may be used for a short time after the interlock switch has opened.</p> <p>This parameter is applicable only if the controller has a main contactor—either an internal main contactor or an external main contactor wired to the main contactor driver (J1 Pin 22).</p> |
| Main Contactor Check | OFF/ON | <p>The main contactor check, when programmed On, performs ongoing checks to ensure that the main contactor closes properly each time it is commanded to close, and that it has not welded closed. These checks are not performed if the parameter is programmed Off. However, the main contactor <u>driver</u> is always protected from overcurrents, short circuits, and overheating.</p> |

| BRAKE MENU | | |
|---------------------------|-----------------|--|
| PARAMETER | ALLOWABLE RANGE | DESCRIPTION |
| Brake Fault Check | OFF/ON | <p>The brake fault check feature, when programmed On, checks the voltage at the brake output (J2 Pin 6) and faults the controller if this voltage does not correspond to the brake voltage demand.</p> <p>Disabling the brake fault check is useful when no electromagnetic brake is wired to the controller because with the check disabled it is not necessary to wire a dummy brake resistor.</p> |
| Brake Delay | 0.0–10.0 sec. | <p>If the motor does not stop when the throttle request is zeroed, the controller will shut down the motor. The brake is then engaged after the programmed brake delay.</p> |
| Brake Hold Voltage | 0–100 % | <p>A short pulse of full battery power is initially applied to the brake driver to release the brake; after this, the PWM voltage on the brake output is reduced to the programmed brake hold voltage. Using a lower voltage for holding the brake reduces brake heating and saves energy.</p> <p>The brake hold voltage must be set high enough to keep the brake released even under extreme conditions (high brake temperature, low battery voltage, vibration, or shock). Setting the parameter too low could result in the brake being engaged accidentally, causing an abrupt stop and excessive motor current.</p> |
| Brake Driver Type | 0–3 | <p>0 = throttle-initiated brake release <i>The brake driver releases the brake when the interlock switch closes and throttle is requested, and engages it when the interlock switch opens or the throttle demand is zeroed. The motor speed is ramped down to zero before the brake driver shuts off. Note: Type 0 is the typical setting.</i></p> <p>1 = direction-switch-initiated brake release <i>The brake driver releases the brake when the interlock switch closes and a direction switch is closed, and engages it when the interlock switch opens or both direction switches are open. The motor speed is ramped down to zero before the brake driver shuts off.</i></p> <p>2 = throttle-initiated brake release, with immediate braking <i>Same as Type 0, except the motor is shut off (without ramping down) and brake engaged as soon as the interlock opens.</i></p> <p>3 = direction-switch-initiated brake release, with immediate braking <i>Same as Type 1, except the motor is shut off (without ramping down) and brake engaged as soon as the interlock opens.</i></p> |
| Anti-Rollback Time | 0–1000 msec. | <p>When the electromagnetic brake is first engaged, the motor output is kept active for the time specified by this parameter; this provides motor torque to hold the vehicle in position on an incline. If the time is set too short the vehicle will roll a short distance, because the brake needs some time to mechanically engage.</p> |



Note: All five brake parameters are applicable when the E-M brake is connected to J2 Pins 3 and 6, as shown in Standard Wiring Configurations A and B. When the brake is connected to J1 Pin 24 (Configuration C), the Brake Hold Voltage and Brake Fault Check parameters are not used.

| EMERGENCY REVERSE MENU | | |
|-------------------------------|-----------------|---|
| PARAMETER | ALLOWABLE RANGE | DESCRIPTION |
| Wiring Check | OFF/ON | <p>When programmed On, the wiring check tests for continuity from the emergency reverse check output (J1 Pin 16) to the emergency reverse input (J1 Pin 15); see Fig. 4, page 8, for the recommended wiring.</p> <p>This parameter applies only to systems that include the emergency reverse feature. If emergency reverse is not being used, this parameter should be programmed Off.</p> |
| Speed | 10–100 % | Defines the maximum speed during emergency reverse. |
| Direction Interlock | OFF/ON | <p>As soon as the emergency reverse button is released, the controller sets the drive output to zero regardless of whether a direction or throttle is still being requested. The direction interlock parameter defines how the controller will return to normal operation from this point.</p> <p>If it is programmed On, the operator can either open both direction switches <i>or</i> cycle the interlock switch to enable normal operation.</p> <p>If it is programmed Off, the only way for the operator to resume normal operation is by opening both direction switches <i>and</i> cycling the interlock switch.</p> |
| Time Limit | 0.0–10.0 sec. | Can be used to provide a time limit on emergency reversing. The controller will set the drive output to zero at the end of the programmed time limit, even if the emergency reverse button is still being pressed. If you prefer emergency reversing to continue as long as the emergency reverse button is being pressed, program the time limit parameter to 0.0. |
| Accel Rate | 0.1–5.0 sec. | Sets the rate at which the controller accelerates in the opposite direction when emergency reverse is activated. Higher values represent slower acceleration and therefore gentler response. More abrupt response can be achieved by decreasing the acceleration rate (i.e., by setting the rate to a lower value). |
| Switch Normally Closed | OFF/ON | <p>When a normally-closed type of emergency reverse switch is used, this parameter must be programmed On.</p> <p>In order to use the emergency reverse wiring check feature, a normally-open type of switch is required and this parameter must therefore be programmed Off.</p> |

MOTOR CONTROL PARAMETERS

The 1230 controls the motor using a combined V/f and slip control algorithm, which is summarized in Figure 15.

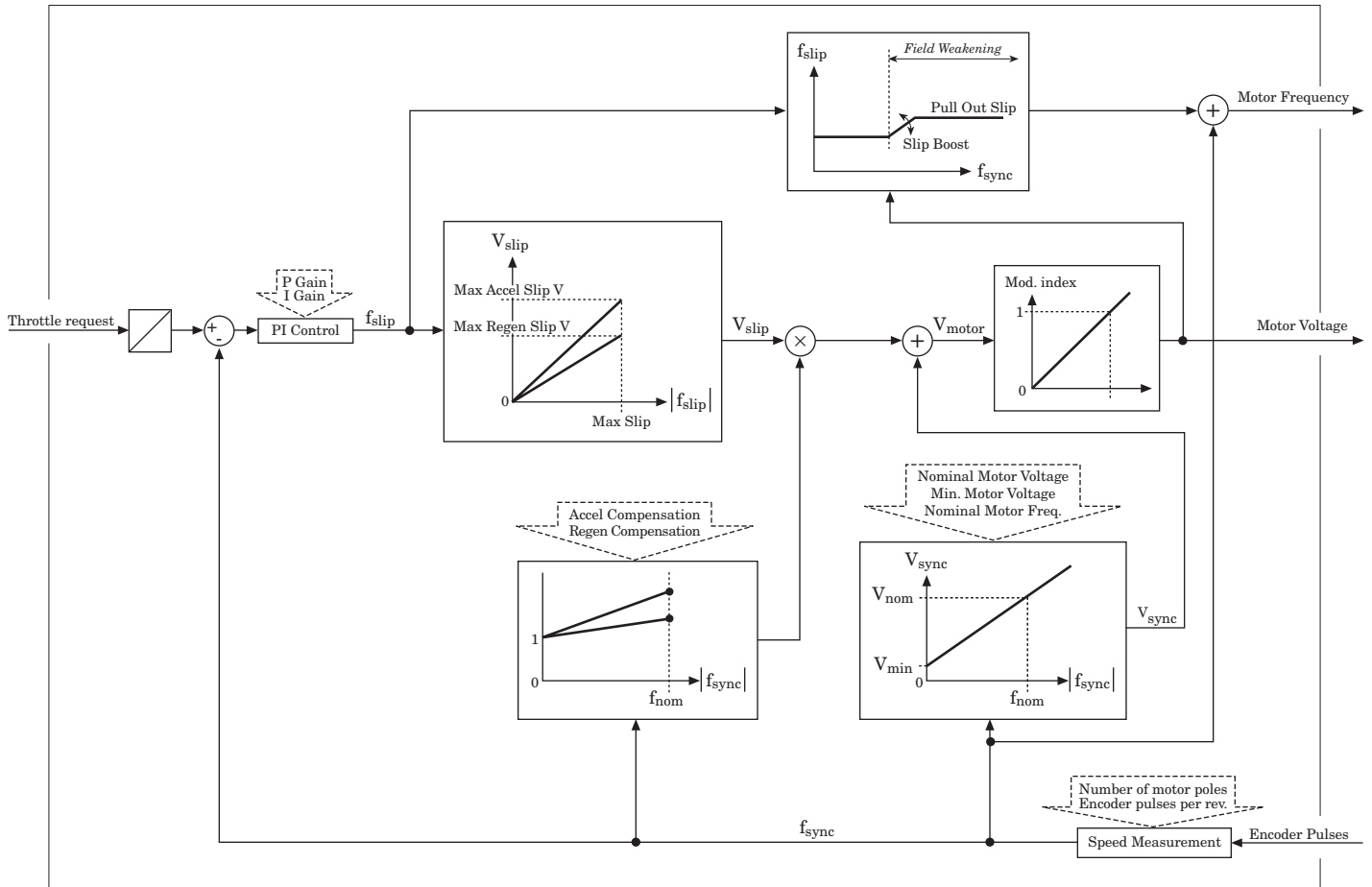

Fig. 15 Overview of motor control algorithm.

The V/f characteristic increases the motor voltage proportional to the motor speed. The V/f profile is normally adjusted to achieve a constant no-load flux in the motor, which means that the no-load motor current is more or less constant over the whole speed range.

The slip control mechanism takes the throttle request (scaled to the motor speed) and compares it with the actual motor speed (measured by means of the speed encoder). The error output is fed into a standard PI control algorithm that controls the slip frequency and slip voltage. Slip voltage is proportional to the slip frequency to compensate for voltage drop across the motor resistance caused by motor current. As the voltage drop is different during acceleration and regeneration, two independent parameters, Max Accel Slip Voltage and Max Regen Slip Voltage, are used to adjust the maximum slip voltage and the resulting maximum motor currents.

| MOTOR MENU | | |
|--------------------------------|-----------------|--|
| PARAMETER | ALLOWABLE RANGE | DESCRIPTION |
| Min Motor Voltage | 0.0–6.0 V | <p>Defines the starting point of the V/f profile. This voltage is applied to the motor at 0 RPM if no (or very low) torque is demanded.</p> <p>Increasing this parameter can improve low speed behavior, because the motor will have flux even at zero throttle request. However, if the parameter is set too high, the motor idle current will be too high, reducing efficiency and increasing the motor temperature.</p> |
| Nominal Motor Voltage | 7–30 V | <p>This parameter should initially be set according to motor nameplate data.</p> <p>The nominal motor voltage parameter and the nominal motor frequency parameter work as a pair to define the slope of the V/f profile.</p> <p>Note: If set too high, excessive current can damage the motor.</p> |
| Nominal Motor Frequency | 20–400 Hz | <p>This parameter should initially be set according to motor nameplate data.</p> <p>The nominal motor voltage parameter and the nominal motor frequency parameter work as a pair to define the slope of the V/f profile.</p> <p>Increasing the nominal motor frequency makes the V/f profile less steep and reduces the no-load motor current.</p> |
| Max Motor Speed | 1000–10000 RPM | <p>Defines the maximum motor RPM at full throttle and a 100% setting of the M1/M2 maximum speed parameter. This parameter can be used to achieve identical fleet top speed and to limit vehicle and motor speed to the safe operating area even when running downhill.</p> <p>Note: If set too high, the bearings and gearbox can be damaged.</p> |
| Number of Motor Poles | 2–8 | <p>This parameter must be set according to motor nameplate data. It is used in calculating the motor output frequency based on the measured encoder input frequency.</p> |
| Encoder Pulses/Rev | 32–128 | <p>This parameter must be set according to motor nameplate data. It is used in calculating the motor output frequency based on the measured encoder input frequency.</p> |
| Swap Encoder Direction | OFF/ON | <p>If the speed encoder A and B signals are wired backwards, this parameter can be used to change the sign of the measured motor speed. It has the same effect as physically swapping the A and B wires on the encoder inputs (J2 Pins 2 and 4).</p> |
| Failsafe Delay | 2–20 sec. | <p>If the motor is turning faster than desired, or in the opposite direction, the controller will shut down the motor and engage the electromagnetic brake after the programmed failsafe delay.</p> |

| CONTROL MENU | | |
|---|----------------------|--|
| PARAMETER | ALLOWABLE RANGE | DESCRIPTION |
| P Gain | 0.00–1.00 | <p>The proportional gain and integral gain parameters define the gain of the proportional and integral fractions of the PI slip control. The optimum settings of these parameters depend on the mechanical design of the vehicle and drive train, which means they must be adjusted empirically through experimental testing.</p> <p>If these parameters are set too low, response to load or throttle steps is slow. Setting them too high can result in jerky drive operation or in speed oscillation.</p> |
| I Gain | 0.00–1.50 | See P Gain, above. |
| Accel Slip, Regen Slip | 1.0–50.0 Hz | <p>The accelerating slip and regenerating slip parameters define the maximum slip during acceleration/deceleration for the constant torque operating area (see Figure 16).</p> <p>Accel slip should be set according the full load slip (maximum current/ maximum torque at nominal motor voltage). Regen slip is typically set about 20% lower, to limit peak current during regeneration because the current vs. slip characteristic is steeper than for acceleration.</p> |
| Slip Boost | 0–10 | Defines the slope of the slip vs. speed characteristic when the controller goes into field weakening. This parameter can be used to adjust constant maximum current in the constant power operating range (see Figure 16). |
| Pull-Out Slip | 1.0–50.0 Hz | Defines the maximum slip for the high speed operating area (see Figure 16). It should be set with sufficient safety margin below the motor's pull-out slip at the maximum motor current. Setting it too high may result in oscillation or torque foldback. |
| Accel Slip Voltage, Regen Slip Voltage | 0.0–10.0, 0.0–5.0 | <p>Define the maximum slip voltage that is added to the V/f profile when maximum slip (and therefore full torque) is requested near zero speed. These parameters allow independent adjustment of the maximum current for accelerating and regenerating (braking).</p> <p>It must be verified that the maximum motor current does not exceed the motor's rated maximum current or the controller's 2-minute rating* under full load conditions.</p> |
| Accel Comp, Regen Comp | 0.0–5.0 | <p>Used to compensate for stray reactance effects. With low compensation values the motor current and torque are reduced with increasing speed. Typically these values are adjusted so that the maximum motor current is constant within the constant torque operating area (see Figure 16).</p> <p>It must be verified that the maximum motor current does not exceed the motor's rated maximum current or the controller's 2-minute rating* under full load conditions.</p> |
| Regen Voltage Offset | 0.0–5.0 | Used to prevent excessive regenerating motor current at low speeds. If the motor current during braking is too high at low speeds, the maximum motor voltage can be reduced by increasing the regen voltage offset. |

* The 2-minute current rating depends on the controller model; see specifications in Table C-1 for the rated current of your model.

Fig. 16 Motor control parameters and their effect on operating characteristics.

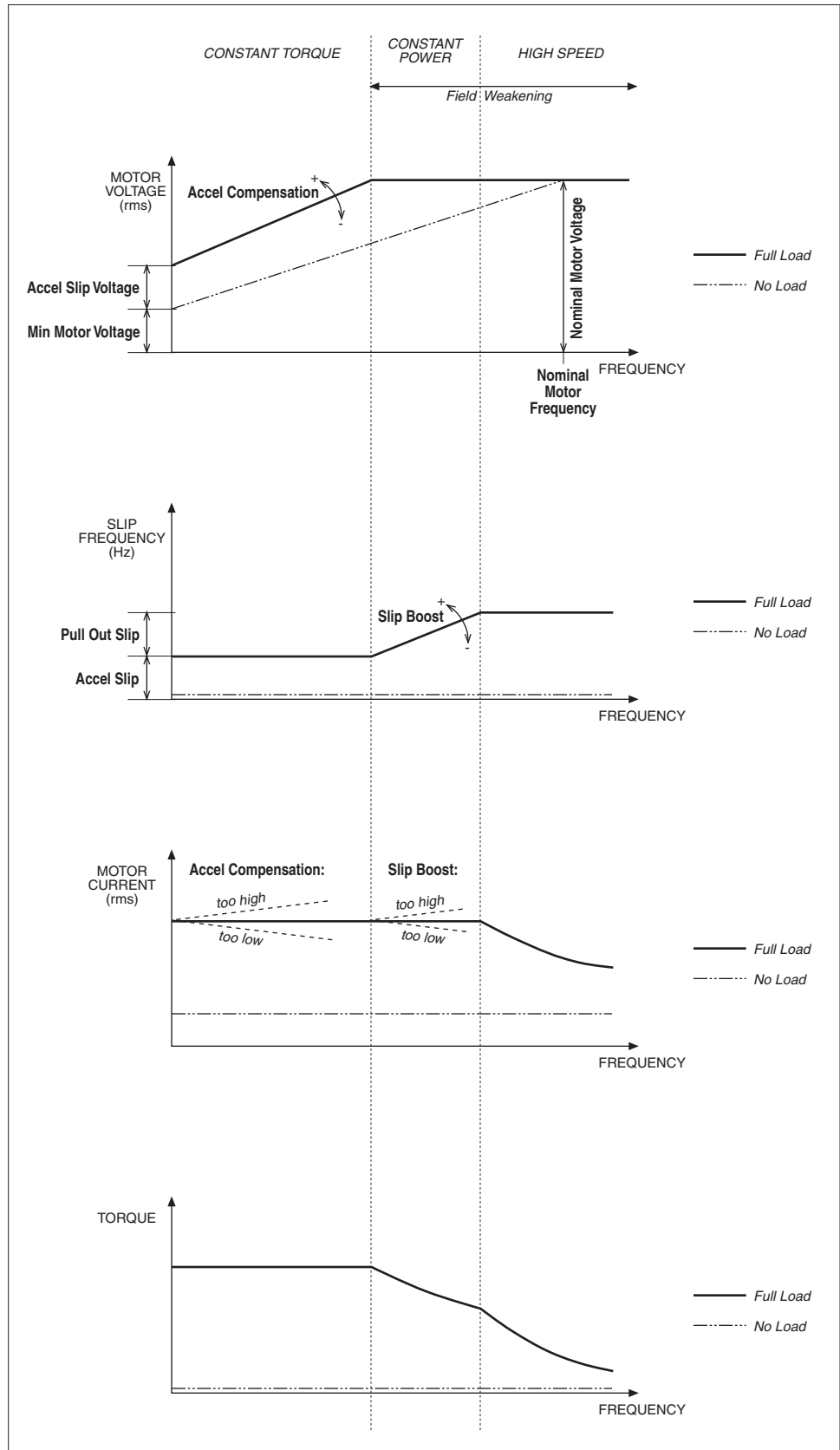

| BATTERY MENU | | |
|---|-------------------------|--|
| PARAMETER | ALLOWABLE RANGE | DESCRIPTION |
| Full Battery Voltage [FBV] | <i>EBV</i> – <i>RBV</i> | Sets the voltage at or above which 100% charge is indicated on the BDI display. The allowable range is from the programmed Empty Battery Voltage up to the BDI Reset Battery Voltage, in VPC (volts per cell) units. |
| Empty Battery Voltage [EBV] | 0.90 VPC – <i>FBV</i> | Sets the voltage at or below which 0% charge is indicated on the BDI display. The allowable range is from 0.90 VPC up to the programmed Full Battery Voltage. |
| BDI Reset Battery Voltage [RBV] | <i>FBV</i> – 3.00 VPC | Sets the no-load voltage at which the controller's battery-state-of-charge calculator will reset to 100%. When this voltage is present for 6 seconds (except during regen braking) the BDI is reset to 100%. The allowable range is from the programmed Full Battery Voltage up to 3.00 VPC. |
| Battery Recharge Level | 20–50 % | Sets the low battery threshold; when the BDI is below the programmed value, the Battery LED will flash. This will alert the operator that the battery will need to be recharged soon. |
| Low Voltage Level | 1.33–1.67 VPC | Sets the voltage considered to be a fully depleted battery (16–20 V). When the battery remains under this voltage consistently, the controller will limit motor speed to 20%. |

The Battery Discharge Indicator constantly calculates the battery state-of-charge when KSI is on. When KSI is turned off, the battery state-of-charge at turn-off is stored in nonvolatile memory. BDI information is viewable via the Spyglass display and via the Monitor Menu of the 13XX programmer.

Note: BDI values are in units of volts per cell. The standard values for flooded lead acid and sealed maintenance-free 24V batteries are as follows:

| | BATTERY TYPE | |
|-------------|---------------------|---------------------|
| | FLOODED | SEALED |
| Full volts | 2.04 VPC [= 24.5 V] | 2.04 VPC [= 24.5 V] |
| Empty volts | 1.73 VPC [= 20.8 V] | 1.90 VPC [= 22.8 V] |
| Reset volts | 2.09 VPC [= 25.1 V] | 2.09 VPC [= 25.1 V] |

Custom values can be entered based on specific batteries in consultation with a Curtis applications engineer.

| HOURMETER MENU | | |
|-----------------------------------|-----------------|---|
| PARAMETER | ALLOWABLE RANGE | DESCRIPTION |
| Enable Total Service Hours | OFF/ON | When programmed Off, the total hourmeter will continue to count the total hours of operation (i.e., KSI on-time) but no action will be taken when the service interval elapses. |
| Enable Drive Service Hours | OFF/ON | When programmed Off, the traction hourmeter will continue to count the hours of drive operation but no action will be taken when the service interval elapses. |
| Adjust Hours | 0–999999 hours | The controller is shipped from the factory with both hourmeters preset to zero. If the controller is being installed in a used vehicle, you can transfer the vehicle's existing hourmeter values to the new controller. The Adjust Hours parameter defines the hours that will be applied as a preset value. Enter the desired preset value, and then use Set Total Hours or Set Drive Hours to apply the preset to the hourmeter. |
| Set Total Hours | OFF/ON | Program this parameter On to load the preset value into the total hourmeter. Once it has been loaded, the parameter is reset to Off automatically. |
| Set Drive Hours | OFF/ON | Program this parameter On to load the preset value into the drive hourmeter. Once it has been loaded, the parameter is reset to Off automatically. |
| Total Service Hours | 100–5000 hours | Sets the timer for the next scheduled overall maintenance. |
| Drive Service Hours | 100–5000 hours | Sets the timer for the next scheduled traction motor maintenance. |
| Total Disable Hours | 0–500 hours | Sets the total disable timer; if the programmed time expires, the Drive Disable Speed goes into effect. |
| Drive Disable Hours | 0–500 hours | Sets the drive disable timer; if the programmed time expires, the Drive Disable Speed goes into effect. |
| Drive Disable Speed | 0–80 % | Sets the maximum drive speed that will be in effect if either of the disable timers expires. It applies to both M1 and M2 Max Speed. |
| Service Total Expired | OFF/ON | When the total service timer expires, the controller automatically sets the Service Total Expired parameter On. The parameter must then be programmed Off to indicated the appropriate service has been performed. |
| Service Drive Expired | OFF/ON | When the drive service timer expires, the controller automatically sets the Service Drive Expired parameter On. The parameter must then be programmed Off to indicated the appropriate service has been performed. |

Two hourmeters (total KSI on-time and traction motor on-time) are built into the 1230 controller. Each has a corresponding service timer and disable timer. The service timer sets the time for periodic maintenance. When the service time expires, the disable timer starts.

HYDRAULICS PARAMETERS

In standard wiring configuration A (page 8), the 1230 provides a feed-through for hydraulics control signals, but otherwise has no relationship to the hydraulics system.

In standard wiring configuration B (page 10), the 1230 turns the pump motor on and off, and opens and shuts the lowering valve; see Figure 17. For these simple systems (Auxiliary Output Type 1, see page 43), only a few of the programmable hydraulics parameters apply.

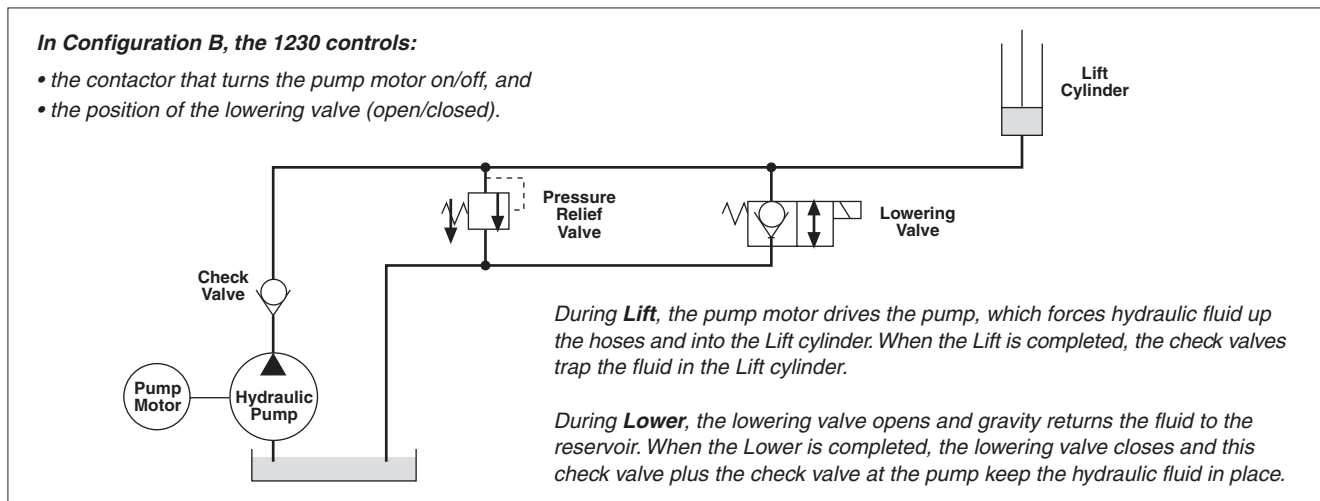

Fig. 17 Simple hydraulic system (standard wiring configuration B).

In standard wiring configuration C (page 12), the 1230 extends its control to the acceleration rate and speed of Lift/Lower operation; see Figure 18. All the hydraulics parameters—including the proportional valve, load hold valve, and hydraulic throttle parameters—apply.

The Auxiliary Output Type parameter (page 43) must be set to 4.

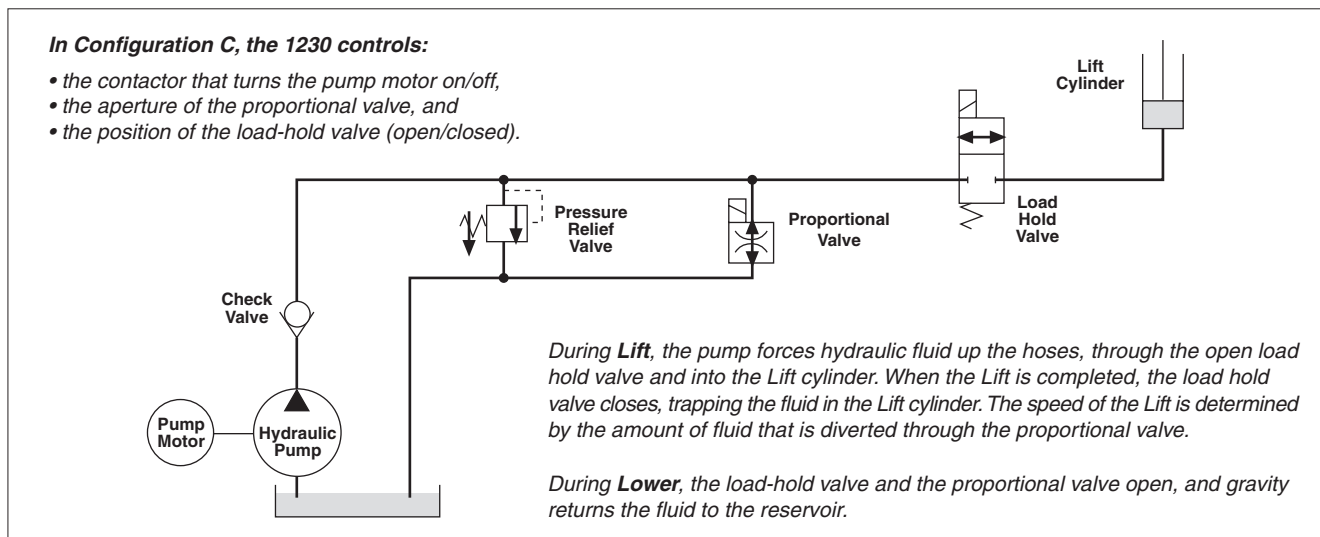

Fig. 18 Hydraulic system with Lift and Lower proportional valve (standard wiring configuration C).

| HYDRAULICS MENU | | |
|----------------------------|-----------------|--|
| PARAMETER | ALLOWABLE RANGE | DESCRIPTION |
| Lift PV Max | 0–100 % | Defines the PWM output to the proportional valve for a Lift request with full hydraulic throttle applied. Lower values provide faster Lift, by allowing less of the hydraulic fluid to be diverted from the Lift operation. |
| Lift PV Min | 0–100 % | Defines the PWM output to the proportional valve for a Lift request with minimal hydraulic throttle applied. Higher values provide slower Lift, by allowing more of the hydraulic fluid to be diverted from the Lift operation. If variable Lift is not desired, set Lift PV Max and Lift PV Min to the same value. |
| Lift PV Accel Rate | 0.0–10.0 sec. | Defines how long it will take the valve current to decrease from 100% to 0% (from fully open to fully closed) during Lift operation. |
| Lift PV Decel Rate | 0.0–10.0 sec. | Defines how long it will take the valve current to increase from 0% to 100% (from fully closed to fully open) during Lift operation. |
| Lower PV Max | 0–100 % | Defines the PWM output to the proportional valve for a Lower request with full hydraulic throttle applied. Higher values result in faster Lower operation, by providing a larger aperture for draining the hydraulic fluid. |
| Lower PV Min | 0–100 % | Defines the PWM output to the proportional valve for a Lower request with minimal hydraulic throttle applied, when Variable Lower is set to On. Lower values result in slower Lower operation, by providing a smaller aperture for draining the hydraulic fluid. If variable Lower is not desired, set Lower PV Max and Lower PV Min to the same value. |
| Lower PV Accel Rate | 0.0–10.0 sec. | Defines how long it will take the valve current to increase from 0% to 100% (from full closed to fully open) during Lower operation. |
| Lower PV Decel Rate | 0.0–10.0 sec. | Defines how long it will take the valve current to decrease from 100% to 0% (from fully open to fully closed) during Lower operation. |
| PV Dither | 0–30 % | Dither provides a constantly changing current in the coil to produce a rapid back-and-forth motion of the valve; this keeps the PV lubricated and allows low-friction, precise movement. The PV Dither parameter specifies the amount of dither as a percentage, and is applied in a continuous cycle of none-add%-none-subtract%. For nonproportional valves, where the valve's opening and closing is spring-activated, dither is not applicable. If your application uses this type of valve, set the PV Dither parameter to 0%. |
| Pump Start Delay | 0–200 msec. | Defines a delay before the pump is started when a new lift action is requested. The actuation of the valves is not affected by this parameter. |
| Pump BDI Lockout | OFF/ON | When programmed On, Lift requests will be ignored as long as the battery state-of-charge is below 20%. When programmed Off, the Lift will continue operating until the undervoltage cutoff point is reached. |

continued

| HYDRAULICS MENU, cont'd | | |
|-----------------------------------|-----------------|--|
| PARAMETER | ALLOWABLE RANGE | DESCRIPTION |
| Lift PV Hold Delay | 0.00–1.00 sec. | Defines how long the PV stays open at the end of a lift operation to allow the pump to stop before the valve closes. |
| Load Hold Delay | 0.00–1.00 sec. | <p>Defines how long the load-hold valve is kept open at the end of a Lift or Lower operation. The delay starts after the PV deceleration time (to allow the valve to close at the completion of a Lift/Lower operation).</p> <p>The load-hold valve is either open or shut, which means that it closes abruptly. It is important to set the delay time long enough to allow the hydraulic fluid to stop flowing before the load-hold valve snaps shut.</p> |
| Open Load Hold During Lift | OFF/ON | When programmed On, the load-hold valve will be kept open during Lift operation. When programmed Off, the load-hold valve will only open for Lower operation. |
| Hyd Throttle Type | 2, 4 | <p>The hydraulic throttle type can be programmed to either 2 or 4:</p> <p>2 <u>single-ended</u> 3-wire 1kΩ–10kΩ potentiometer, 0–5V voltage source, or current source</p> <p>4 <u>wigwag</u> 3-wire 1kΩ–10kΩ potentiometer, or 0–5V voltage source</p> |
| Hyd Throttle Deadband | 0–30 % | <p><i>These three hydraulic throttle adjustment parameters work like their traction throttle counterparts; see text on page 28 and Figure 14 on page 29.</i></p> |
| Hyd Throttle Max | 40–100 % | |
| Hyd Throttle Map | 5–90 % | |
| Max Pump Run Time | 0.0–60.0 sec. | Limits the time the pump runs continuously. Note: The pump run time is not limited if the parameter is set to 0.0 or if proportional hydraulics are selected (Aux Output Type = 4, see Other System Parameters menu). |

OTHER SYSTEM PARAMETERS MENU

| PARAMETER | ALLOWABLE RANGE | DESCRIPTION |
|------------------------------|-----------------|--|
| Power Save Delay | 0–240 min. | <p>Defines the time the controller will remain in standby* before switching to power save mode; the controller will leave power save mode and resume normal operation as soon as the interlock switch is closed or the keyswitch is cycled. If the delay is set to 0, the controller will never switch to power save mode.</p> <p>*The vehicle is in standby when it is not moving, the interlock switch is open, and no programming device is connected.</p> |
| Mux Inputs Enabled | OFF/ON | When programmed On, enables the multiplexer (wired to J1 Pins 9–12). |
| Inhibit Input Type | 0–2 | <p>Configures the Inhibit input at J1 Pin 4:</p> <p>0 = no Inhibit <i>Inhibit input is ignored.</i></p> <p>1 = normally open Inhibit <i>Motor output inhibited when Inhibit switch is closed (Inhibit input high).</i></p> <p>2 = normally closed Inhibit <i>Motor output inhibited when Inhibit switch is open (Inhibit input low).</i></p> |
| Auxiliary Output Type | 0–8 | <p>Configures the auxiliary output drivers at J1 Pins 23 and 24:</p> <p>0 = no auxiliary output <i>Both auxiliary outputs are disabled.</i></p> <p>1 = multiplexer Lift/Lower <i>Aux Output 1 is controlled by the multiplexer's Lift switch; Aux Output 2 is controlled by the multiplexer's Lower switch.</i></p> <p>2 = multiplexer horn <i>Aux Output 1 is controlled by the multiplexer's horn switch; Aux Output 2 is disabled.</i></p> <p>3 = backup alarm <i>Aux Output 1 is pulsed when motor is turning in reverse; Aux Output 2 is pulsed when motor is turning forward.</i></p> <p>4 = multiplexer proportional Lift/Lower <i>Aux Output 1 is used for the electromagnetic brake; Aux Output 2 is controlled by the multiplexer's Lift and Lower switches.</i></p> <p>5 = continuous backup alarm <i>Aux Output 1 is on when motor is turning in reverse; Aux Output 2 is on when motor is turning forward.</i></p> <p>6 = BDI lockout <i>Aux Output 1 is on when battery state-of-charge is <20% or battery voltage is below the programmed Low Voltage Threshold; Aux Output 2 is off when battery state-of-charge is <20% or battery voltage is below the programmed Low Voltage Threshold.</i></p> <p>7 = brake light and backup alarm <i>Aux Output 1 is on when motor is braking; Aux Output 2 is pulsed when motor is turning in reverse.</i></p> <p>8 = (reserved)</p> |

| OTHER SYSTEM PARAMETERS MENU, cont'd | | |
|--------------------------------------|-----------------|--|
| PARAMETER | ALLOWABLE RANGE | DESCRIPTION |
| Fault Code | OFF/ON | <p>Configures the status LED driver (J1 Pin 17) to display fault information in Fault Code format or Fault Category format:</p> <p>On = Fault Code format <i>The status LED driver provides a pulsed signal equivalent to the fault code flashed by the controller's built-in status LED; these codes are listed in Table 3, page 54.</i></p> <p>Off = Fault Category format <i>The status LED driver indicates three different categories of faults; these categories are listed in Table 4, page 55.</i></p> |

CLONING (for copying parameter settings to multiple controllers)

Once a controller has been programmed to the desired settings, these settings can be transferred as a group to other controllers, thus creating a family of “clone” controllers with identical settings. Note: Cloning only works between controllers with the same model number and software version. For example, the programmer can read all the information from a 1230-2101 controller and write it to other 1230-2101 controllers; however, it cannot write that same information to 1230-2102 controllers.

To perform cloning, plug the 13XX programmer into the controller that has the desired settings. Scroll down to the Functions menu; “Clone” is the only function included here. Select “Get Settings From Controller” to copy the settings into the programmer.

Plug the programmer into the controller that you want to have these same settings, and select “Write Settings To Controller.”

4

MONITOR MENU

Through the monitor menu, the 13XX programmers provide access to real-time data during vehicle operation. This information is helpful during diagnostics and troubleshooting, and also during programmable parameter adjustment.

| MONITOR MENU | |
|--------------------------|--|
| ITEM | VALUE DISPLAYED |
| MOTOR + BATTERY | |
| Battery Voltage | Voltage at KSI, in volts. |
| BSOC | Battery state of charge. |
| Motor Speed | Motor speed, in revolutions per minute. |
| Motor Voltage | Motor voltage, in volts. |
| Motor Frequency | Motor frequency, in hertz. |
| Slip | Motor slip frequency, in hertz. |
| INPUTS | |
| Throttle Input | Throttle request: traction throttle. |
| Interlock Switch | Interlock switch, on/off. |
| Forward Switch | Forward switch, on/off. |
| Reverse Switch | Reverse switch, on/off. |
| Mode Switch | Mode switch, on/off. |
| Emergency Reverse Switch | Emergency reverse switch, on/off. |
| Inhibit Input | Inhibit input, on/off. |
| Speed Limit | Speed limit request from pot or switch. |
| Horn Switch | Horn switch on or off. |
| Hyd Throttle Input | Throttle request: hydraulic throttle. |
| Lift Switch | Lift switch, on/off. |
| Lower Switch | Lower switch, on/off. |
| OUTPUTS | |
| Aux Output 1 | Aux 1 driver output. |
| Aux Output 2 | Aux 2 driver output. |
| Prop Valve PWM | Proportional valve PWM output. |
| Load Hold Valve | Load hold valve driver output. |
| CONTROLLER | |
| Temperature | Controller internal temperature (MOSFETs). |
| Main Contactor | Main contactor, open/closed. |
| Total Hourmeter Hours | Total service hourmeter, in hours. |
| Drive Hourmeter Hours | Drive service hourmeter, in hours. |
| Fault Position | Additional fault information. |

5

INITIAL SETUP

It is imperative that these initial setup procedures be carefully followed to ensure that the controller is set up to be compatible with your application. Do not drive the vehicle until initial setup has been completed.

The following information should be obtained from the motor label or from the motor manufacturer:

- nominal motor voltage
- nominal motor frequency
- maximum motor speed
- number of motor poles
- encoder pulses per revolution
- maximum motor current.

Before starting the setup procedures, **jack the vehicle drive wheels up off the ground so that they spin freely.** Doublecheck all wiring to ensure that it is consistent with the wiring guidelines presented in Section 2. Make sure all connections are tight.

Turn on the controller, but leave the interlock switch open (in the “Park” position). Plug in the 13XX programmer.

① **Motor setup** (see page 35)

The first thing that you need to do is set up the controller to match your motor, using the parameters in the Motor menu. The 1230 controller has the flexibility to be tuned to nearly any AC induction motor from any manufacturer.

Use these guidelines to set the motor parameters initially:

| RECOMMENDED INITIAL MOTOR PARAMETER SETTINGS | |
|--|---|
| PARAMETER | INITIAL SETTING |
| Min Motor Voltage | 0.0 |
| Nominal Motor Voltage | According to manufacturer's data. |
| Nominal Motor Frequency | According to manufacturer's data. |
| Max Motor Speed | Maximum motor speed or maximum vehicle speed, whichever is lower. |
| Number of Motor Poles | According to manufacturer's data. |
| Encoder Pulses Per Rev. | According to manufacturer's data. <i>[If necessary, measure with a storage oscilloscope by counting the pulses for one revolution.]</i> |
| Swap Encoder Direction | Off. <i>[To check, release the brake and spin the drive wheels forward. If the motor speed value (Monitor > Motor & Battery > Motor Speed) is negative, set Swap Encoder Direction On.]</i> |

② Control setup (see page 36)

Use these guidelines to set the parameters in the Control menu initially:

| RECOMMENDED INITIAL CONTROL PARAMETER SETTINGS | |
|--|---|
| PARAMETER | INITIAL SETTING |
| P Gain | 0.1 |
| I Gain | 0.1 |
| Accel Slip | <i>Motor Frequency – (Motor Poles × Motor Speed / 120); typically 3 – 6 Hz.</i> |
| Decel Slip | About 20% lower than Accel Slip; typically 2.5 – 5.5 Hz. |
| Slip Boost | 1 |
| Pull Out Slip | According to motor manufacturer; typically 6 – 12 Hz (about 2 × Accel Slip). |
| Accel Slip Voltage | 3.0 * |
| Regen Slip Voltage | 0.3 ** |
| Accel Compensation | 1 |
| Regen Compensation | 3 |
| Regen Voltage Offset | 0 |

*Alternatively, you can make a rough estimate of Accel Slip Voltage as follows:
Maximum Motor Current [A] × Motor Stator Resistance [ohms] (phase to phase).

**Alternatively, you can make a rough estimate of Regen Slip Voltage by setting it to 10% of Accel Slip Voltage.

③ Throttle (see page 28)

The Throttle Type parameter must be set to match the type of throttle you will be using (Type 1–5). If you are using a Type 5 three-step switch throttle, skip to procedure ④ after setting the Throttle Type to 5.

If you are using a Type 1–4 throttle, use the following procedure to adjust the Throttle Deadband and Throttle Max parameters to match the range of your throttle; this will ensure that the controller output is operating over its full range. It is advisable to allow some buffer around the absolute full range of the throttle mechanism to allow for throttle resistance variations over time and temperature as well as variations in the tolerance of potentiometer values between individual throttle mechanisms.

Tuning the Throttle Deadband

- ③-a. Make sure the interlock switch is open, and turn on the keyswitch.
- ③-b. Observe the Monitor > *Inputs* > Throttle Input parameter; you will need to reference the value displayed here.
- ③-c. Scroll down to the Forward Input parameter; the display should indicate that the forward switch is Off.
- ③-d. Slowly rotate the throttle forward until the display indicates that the forward switch is On. Use care with this step as it is important to identify the threshold throttle position at which the forward switch is engaged and the controller recognizes the forward command.
- ③-e. Without moving the throttle, read the value shown for the Throttle Input parameter. This value should be zero. If the Throttle Input value is zero, proceed to step 3-f. If it is greater than zero, the Throttle Deadband must be increased (Program > *Vehicle* > Throttle > Throttle Deadband). Repeat steps 3-d and 3-e until the Throttle Input monitor value is zero at the forward direction engagement point.
- ③-f. While observing the Throttle Input monitor value, continue to rotate the throttle past the forward switch engagement point. Note where the Throttle Input value begins to increase, indicating that the controller would begin to supply drive power to the motor (if the interlock were closed). If the throttle had to be rotated further than desired before the Throttle Input value began to increase, the Throttle Deadband must be decreased and the procedure repeated from step 3-d. If the amount of rotation between the point at which the forward switch is engaged and the Throttle Input value begins to increase is acceptable, the Throttle Deadband is properly tuned.
- ③-g. If a bidirectional (wigwag) throttle assembly is being used, the procedure should be repeated for the reverse direction. The Throttle Deadband value should be selected such that the throttle operates correctly in both forward and reverse.

Tuning the Throttle Max

- ③-h. Rotate the throttle forward to its maximum speed position and observe the Throttle Input value. This value should be 100%. If it is less than 100%, the Throttle Max value must be decreased to attain full controller output at the maximum throttle position (Program > *Vehicle* > Throttle > Throttle Max). Repeat until the Throttle Input value is 100%.
- ③-i. Now that the full throttle position results in a 100% value for Throttle %, slowly reduce throttle until the Throttle % value drops below 100% and note the throttle position. This represents the extra range of motion allowed by the throttle mechanism. If this range is large, you may wish to decrease it by increasing the Throttle Max value. This will provide a larger active throttle range and more vehicle control. Increase Throttle Max and repeat the test until an appropriate amount of extra range is attained.
- ③-j. If a wigwag throttle is being used, repeat the procedure for the reverse direction. The Throttle Max value should be selected such that the throttle operates correctly in both forward and reverse.

④ Initial adjustment of motor control parameters (see pages 36 and 37)

The performance of an AC induction motor is significantly influenced by temperature. Therefore, the following procedure should be performed with a warm motor.



④-a. With the interlock switch closed, select a direction and apply throttle. The motor should begin to turn in the selected direction. If it does not, first verify the wiring to the throttle and the forward and reverse switches. If the wiring is correct, turn off the controller, disconnect the battery, and exchange the motor's U and V cables on the controller. The motor should now turn in the proper direction. **CAUTION:** The order of the U, V, and W connections will affect the operation of the emergency reverse feature. The forward and reverse switches and the motor phase connections must be configured so that the vehicle drives away from the operator when the emergency reverse button is pressed.

④-b. Turn on the controller. Stall the motor; you can do this by applying the brake (by simply unplugging the J2 connector, if your application uses standard wiring configuration A or B). With the interlock switch closed, select a direction and apply full throttle for about 3 seconds. Measure the maximum motor phase current with a suitable RMS current clamp; the clamp must be accurate at frequencies as low as 5–10 Hz. Note: if you apply the throttle for a longer time, the anti-stall protection feature will shut down the controller after about 5 seconds.

④-c. Increase the Accel Slip Voltage parameter, apply throttle, and measure the max current as in step 4-b. Repeat until the measured current is as desired. To avoid damage to the motor or to the controller, make sure the maximum measured motor phase current is not higher than the motor's maximum current rating or the controller's 2-minute rating.

④-d. Set the Regen Slip Voltage parameter to about 20% of the Accel Slip Voltage parameter value determined in step 4-c. As regenerative current flows in the opposite direction and causes negative voltage across the internal resistance, the required voltage to produce the same current as for accelerating is lower. If the Regen Slip Voltage is set too high, this regenerative behavior would lead to excessive motor current during braking.

⑤ Basic vehicle checkout

After completing procedures ① through ④, use the programmer to check the wiring. Cycle each switch, observing its status in the Monitor Menu; if your application has a multiplexer, check the wiring of its switches, also.

Turn on the keyswitch, close the interlock, select a direction, and apply throttle. The motor should run proportionately faster with increasing throttle. If it does not, you must find the problem and fix it before continuing; see the troubleshooting suggestions in Section 7. **Do not take the vehicle down off the blocks until the motor is responding properly.**

⑥ Fine tuning of motor control parameters *(see page 36)*

This procedure is conducted after the vehicle is taken down off the blocks. If a motor or vehicle test bench is available, it should be used for this procedure as it is the easiest and most accurate way to make these adjustments. Otherwise, perform this procedure while driving the vehicle. **Be extremely careful** when driving the vehicle during this procedure. Be sure there is plenty of room around the vehicle. Operating on a ramp will allow you to apply varying torque loads.

⑥-a. Measure the no load motor current at different speeds. Increase the Min Motor Voltage parameter until the motor current at low speed is the same as at mid to high speeds.

⑥-b. Stall the motor and measure the torque and motor current for different Accel Slip parameter settings. Adjust the Accel Slip to the value with the highest torque/current ratio. Adjust the Accel Slip Voltage to achieve the desired maximum motor current.

⑥-c. Measure the full load motor current at different speeds within the constant torque operating area (see Figure 16). Increase the Accel Compensation parameter until the maximum motor current is constant in this operating area.

⑥-d. Measure the full load torque in the high speed range with different settings for the Pull Out Slip parameter. Set the Pull Out Slip to the value with the highest torque measurement.

⑥-e. Measure the full load motor current at different speeds within the constant power operating area (see Figure 16). Increase the Slip Boost parameter until the maximum motor current is constant within the constant torque operating area.

⑥-f. Measure the torque and motor current at medium speed and full regeneration for different Regen Slip parameter values. Set the Regen Slip to the value with the highest torque/current ratio.

⑥-g. Measure the full regeneration motor current at low speed (about 20% of Nominal Motor Frequency). Adjust the Regen Slip Voltage until the motor current is approximately the same as for full load accelerating.

⑥-h. Measure the full regeneration motor current at different speeds within the constant torque operating area (see Figure 16). Increase the Regen Compensation parameter until the maximum motor current is constant across the constant torque operating area.

⑥-i. Measure the full regeneration motor current at different very low speeds (about 5 to 15% of Nominal Motor Frequency). Adjust the Regen Offset Voltage to limit the maximum motor current to the same level as for full load accelerating. Note: Especially for higher power motors it may be impossible to get a constant maximum regenerating current; to find the best compromise, repeat steps 6-g through 6-i iteratively.

When the initial setup has been successfully completed, use the guidelines in Section 6 to adjust the various programmable parameters as needed to provide the desired performance.

6

VEHICLE PERFORMANCE ADJUSTMENT

The 1230 controller's wide variety of adjustable parameters allows many aspects of vehicle performance to be optimized. This section provides explanations of what the major tuning parameters do and instructions on how to use these parameters to optimize the performance of your vehicle. Traction system tuning is described first, followed by hydraulic system tuning.

The tuning procedures should be conducted in the sequence given, because successive steps build upon the ones before. It is important that the effect of these programmable parameters be understood in order to take full advantage of the 1230 controller's powerful features. Please refer to the descriptions of the applicable parameters in Section 3 if there is any question about what any of them do.

The 1230's MultiMode™ feature allows the vehicle to be configured to provide two distinct operating modes. Typically, Mode 1 is optimized for precision maneuvering and Mode 2 for faster outdoor travel. If your vehicle is intended to operate in two modes, some of the tuning procedures must be performed twice—once for each mode.

Three performance characteristics are usually tuned on a new vehicle:

- ⑦ Dynamic response
- ⑧ Speed, acceleration, deceleration, and brake rates
- ⑨ Hydraulic system.

⑦ Tuning the vehicle's dynamic response (Control menu parameters)

This procedure accomplishes the major tuning of the vehicle's response, using the P Gain and I Gain parameters (Program > *Control* > P Gain, I Gain). During this procedure, operate the vehicle in Mode 1.

⑦-a. First, set the M1 Accel, Decel, and Brake rates to small values, corresponding to the fastest required rates for your application.

⑦-b. Test the vehicle's response to abrupt throttle changes. Increase the P Gain value until the behavior is responsive but not jerky.

⑦-c. Test the vehicle's response to low throttle inputs when starting on a slope. Increase the I Gain value until the rollback distance is acceptable.

⑦-d. Retest the vehicle's response to abrupt throttle changes. Decrease the I Gain and P Gain values if the behavior is jerky.

⑧ Tuning the vehicle's speed, acceleration, deceleration, and brake rates

The fine tuning of the vehicle's response is accomplished using the rate parameters (Program > *Vehicle* > Rates), see page 25; the speed parameters (Program > *Vehicle* > Speeds), see page 26; and the throttle parameters (Program > *Vehicle*

> Throttle), see pages 28–29. This procedure adjusts characteristics related to the “feel” of the vehicle.

Ⓢ-a. Speed (Speed Limit Type, M1/M2 Max Speed, M1/M2 Min Speed). First, set the Speed Limit Type parameter to match the type of speed limit input your application will use.

Two speed setpoints are set in each operating mode: the speed at full throttle when the speed limit pot is in its highest position (Max Speed) and the speed at full throttle when the speed limit pot is in its lowest position (Min Speed).

These parameters are set through experimentation. If the vehicle speed is too fast, reduce the setting; if it is too slow, increase the setting.

Ⓢ-b. Response to increased throttle (Throttle Map, M1/M2 Accel Rate). Set the Throttle Map parameter to 50%. Drive the vehicle and adjust the Accel Rate for the best overall response. If the vehicle starts too slowly under all driving conditions, reduce the Accel Rate.

The throttle map can be adjusted if necessary to achieve the desired control at low speeds. If the vehicle responds well for fast, full range throttle transitions but is too jumpy during low speed maneuvering, reduce the Throttle Map value; see Figure 14, page 29. On the other hand, if you want a faster, more responsive feel at low throttle, increase the Throttle Map value.

Ⓢ-c. Response to decreased throttle (M1/M2 Decel Rate). The way the vehicle responds when the throttle is reduced or completely released is adjusted using the Decel Rate parameter. First, set the Decel Rate based on the desired time for the vehicle to stop upon release of throttle when traveling at full speed with full load. If the vehicle brakes too abruptly when the throttle is released, increase the Decel Rate.

Ⓢ-d. Response to a new direction command (M1/M2 Brake Rate). The way the vehicle responds when a new direction is selected is adjusted using the Brake Rate parameter. First, set the Brake Rate based on the desired time for the vehicle to stop upon selecting a new direction when traveling at full speed with full load. If the vehicle brakes too abruptly when the new direction is selected, increase the Brake Rate.

Note: Once a vehicle/motor/controller combination has been tuned, the parameter values can be made standard for that system or vehicle model. Any changes in the motor, the vehicle drive system, or the controller will require that the system be tuned again to provide optimum performance.

⑨ Hydraulic system tuning

Tuning the hydraulic system is more straightforward than tuning the drive system, because the parameters are not as inter-related. Nonetheless, it is important that the effect of these programmable parameters be understood; please refer to the description of the hydraulic parameters on pages 39–41.

If your application does not use a hydraulic throttle (standard wiring configuration B), it does not need to be tuned; set the Lift/Lower PV Min values to 0%, the Lift/Lower PV Max values to 100%, and the Lift/Lower Accel and Decel rates to 0. If your application includes a hydraulic throttle (standard wiring configuration C), use the following tuning procedure.

⑨-a. Select the appropriate Hydraulic Throttle Type (2 or 4), and then set the other throttle parameters: Hydraulic Throttle Deadband, Hydraulic Throttle Max, and Hydraulic Throttle Map. Initially, use these default settings: DB=10%, throttle max=100%, and map=50%.

⑨-b. Tune the active throttle range. Adjust the deadband and throttle max settings using the multi-step procedures outlined for their traction throttle equivalents on page 48.

⑨-c. If variable-speed Lower is desired, set the Variable Lower parameter to On.

⑨-d. Set the Lift/Lower PV Max and Min values based on the valve manufacturer's ratings.

⑨-e. Fine-tune the Lift PV Max and Min values by watching the Prop Valve PWM value (Monitor > *Outputs* > Prop Valve PWM) while you operate the throttle. Slowly increase the Lift throttle until the Lift cylinder begins to rise; use the displayed Prop Valve PWM value for Lift PV Min (Program > System > *Hydraulics* > Lift PV Min). Push the throttle further until the Lift speed is no longer increasing; use the displayed Prop Valve PWM value for Lift PV Max.

⑨-f. Fine-tune the Lower PV Max and Min values using the procedure described in step 9-e for their Lift equivalents.

⑨-g. To further tune the Lift response, adjust the Lift Accel and Decel rates. Similarly, to further tune the Lower response, adjust the Lower Accel and Decel rates.

⑨-h. If a bump is felt at the end of Lift operations, increase the Lift PV Hold Delay value to allow the hydraulic fluid to stop flowing before the proportional valve closes.

Note: Once a valve/motor/controller combination has been tuned, the parameter values can be made standard for that system or vehicle model. Any changes in the hydraulic system or the controller will require that the system be tuned again to provide optimum performance.

7

DIAGNOSTICS AND TROUBLESHOOTING

Diagnostic information is provided by the fault codes flashed by the Status LED, the fault display on the Spyglass gauge, and the Faults menu on the 1311 programmer. Refer to the troubleshooting chart at the end of this section for suggestions covering a wide range of possible faults.









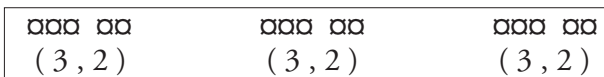









LED DIAGNOSTICS

The Status LED output at J1-Pin 17 provides either fault codes (Table 3) or fault categories (Table 4), depending on how the Fault Code parameter is set. The built-in Status LED located on top of the controller always provides fault codes.

LED Fault Codes

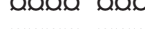
During normal operation, with no faults present, the Status LED flashes steadily. If the controller detects a fault, a 2-digit fault code is flashed until the fault is corrected. For example, code “3,2”—main contactor fault—appears as:



| LED CODES | EXPLANATION |
|---|---|
| <i>LED off</i>  | no power or defective controller |
| <i>solid on</i>  | controller or microprocessor fault |
| 0,1  | controller operational; no known faults |
| 1,2  | motor speed encoder or failsafe fault |
| 1,3  | motor overcurrent or wiring fault |
| 1,4  | SRO sequencing error |
| 2,1  | throttle wiper high |
| 2,2  | emergency reverse wiring fault |
| 2,3  | HPD sequencing error |
| 2,4  | throttle wiper low |
| 3,1  | tiller multiplexer fault |
| 3,2  | main contactor or precharge fault |
| 3,3  | brake fault |
| 4,1  | expired hourmeter timer |
| 4,2  | battery over-/under-voltage |
| 4,3  | controller over-/under-temperature |
| 4,4  | anti-tiedown fault |
| 5,1  | controller failure |
| 5,2  | controller failure |
| 5,3  | controller failure |

Note: Only one fault is indicated at a time. Faults are not queued up.

LED Fault Categories

In the “fault category” format, the LED indicates one of three categories. Because the category does not provide diagnostic information, you will need to use the programmer to find out what the problem is.

| CATEGORY | INDICATION |
|--------------------------|--------------------------------------|
| <i>No faults present</i> | Status LED shows heartbeat. |
| <i>Warning</i> | Status LED is flashing at 2 Hz rate. |
| <i>Fault</i> | Status LED is continuously on. |

SPYGLASS DIAGNOSTICS

The eight-character LCD on the Spyglass displays a continuous sequence of hourmeter, battery state-of-charge, and fault messages.

Fault messages are displayed using the same codes that are flashed by the LED. For example, the LED flashes 3,2 (000 00) for a main contactor fault, and the corresponding Spyglass display is CODE 32.

PROGRAMMER DIAGNOSTICS

The 13XX programmer presents diagnostic information in plain language. All currently set faults are displayed in the Diagnostics Menu (see second column in the troubleshooting chart), and the status of the controller inputs/outputs is displayed in the Monitor Menu.

TROUBLESHOOTING CHART

The troubleshooting chart, Table 5, provides suggestions covering a wide range of possible faults.



Whenever a controller fault is encountered and no wiring or vehicle fault can be found, shut off KSI and turn it back on to see if the fault clears. If not, shut off KSI and remove the J1 and J2 connectors. Check the connectors for corrosion or damage, clean them if necessary, and re-insert them.

Table 5 TROUBLESHOOTING CHART

| CODE | PROGRAMMER LCD DISPLAY | EXPLANATION | POSSIBLE CAUSE |
|------|-------------------------------|--|---|
| 1,2 | Motor Speed Encoder | Motor speed encoder pulses are not correct. | 1. Incorrect encoder wiring. 2. Controller defective. |
| | Motor Failsafe | Motor stalled, or motor turning faster than desired. | 1. Incorrect encoder wiring. 2. Motor blocked. 3. Insufficient braking torque. 4. Motor control P Gain and I Gain settings too low. 5. Failsafe delay too short. |
| 1,3 | Motor Overcurrent | Motor phase overcurrent. | 1. Incorrect motor wiring. 2. Controller defective. |
| | Motor Output Fault | Motor output protection feature has been triggered. | 1. Incorrect motor wiring. 2. Controller defective. |
| 1,4 | Static Return To Off | SRO sequencing error. | 1. Improper sequence of KSI, interlock, and direction inputs. 2. Wrong SRO type selected. 3. Misadjusted throttle pot. 4. Direction switch open. 5. Sequencing delay too short. 6. Wrong throttle type selected. |
| 2,1 | Throttle Wiper High | Throttle wiper voltage is too high. | 1. Throttle input wire shorted to B+. 2. Defective throttle pot. 3. Wrong throttle type selected. 4. Incorrect speed limit pot wiring. |
| 2,2 | Emergency Reverse Wiring Open | Emergency reverse wiring fault. | 1. Emerg. Rev. wire or check wire broken. |
| 2,3 | High Pedal Disable | HPD sequencing error. | 1. Improper sequence of KSI, interlock, and throttle inputs. 2. Wrong HPD type selected. 3. Misadjusted throttle pot. 4. Interlock switch open. 5. Sequencing delay too short. 6. Wrong throttle type selected. |
| 2,4 | Throttle Wiper Low | Throttle wiper voltage is too low. | 1. Throttle input wire shorted to B-. 2. Defective throttle pot. 3. Wrong throttle type selected. |
| 3,1 | Multiplexer Fault | Tiller multiplexer error. | 1. MUX card not plugged in. 2. MUX not wired properly. 3. MUX card defective. |
| 3,2 | Main Contactor | Missing or welded main contactor. | 1. Main contactor coil open. 2. Main contactor missing. 3. Wire to main contactor missing. 4. Main contactor stuck closed. 5. Main contactor driver shorted. |
| | Precharge | Precharge fault. | 1. Controller defective. 2. Low battery voltage. |

Table 5 TROUBLESHOOTING CHART, *continued*

| CODE | PROGRAMMER LCD DISPLAY | EXPLANATION | POSSIBLE CAUSE |
|------|---------------------------|---|---|
| 3,3 | Brake Fault | Brake wiring or driver fault. | <ol style="list-style-type: none"> 1. Brake coil open. 2. Brake missing. 3. Wire to brake missing. 4. Brake driver shorted. |
| 4,1 | Service Total Disabled | Total disable timer has expired. | 1. Expired total disable timer. |
| | Service Drive Disabled | Drive disable timer has expired. | 1. Expired drive disable timer. |
| | Service Total Expired | Total maintenance timer has expired. | 1. Expired total maintenance timer. |
| | Service Drive Expired | Drive maintenance timer has expired. | 1. Expired drive maintenance timer. |
| 4,2 | Battery Overvoltage | Battery voltage is too high. | <ol style="list-style-type: none"> 1. Battery voltage >overvoltage cutback limit. 2. Operation with charger attached. |
| | Battery Undervoltage | Battery voltage is too low. | <ol style="list-style-type: none"> 1. Battery voltage <undervoltage cutback limit. 2. Corroded battery terminal. 3. Loose battery or controller terminal. |
| 4,3 | Temperature Cutback | Controller heatsink is too hot or too cold. | <ol style="list-style-type: none"> 1. Temperature >85°C or <-25°C. 2. Excessive load on vehicle. 3. Improper mounting of controller. 4. Operation in extreme environment. |
| 4,4 | Anti Tiedown | Mode switch activated at startup. | <ol style="list-style-type: none"> 1. Mode switch shorted to B+. 2. Mode switch “tied down” to select M2 permanently. |
| 5,1 | Hardware Failure | Hardware failure. | 1. Controller defective. |
| 5,2 | Software Failure | Software failure. | 1. Controller defective. |
| 5,3 | Parameters Corrupt | Parameters corrupt. | 1. Controller defective. |

8

MAINTENANCE

There are no user serviceable parts in the Curtis 1230 controller. **No attempt should be made to open, repair, or otherwise modify the controller.** Doing so may damage the controller and will void the warranty.

It is recommended that the controller and connections be kept **clean and dry** and that the controller's diagnostics history file be checked and cleared periodically.

CLEANING

Periodically cleaning the controller exterior will help protect it against corrosion and possible electrical control problems created by dirt, grime, and chemicals that are part of the operating environment and that normally exist in battery powered systems.



When working around any battery powered system, proper safety precautions should be taken. These include, but are not limited to: proper training, wearing eye protection, and avoiding loose clothing and jewelry.

Use the following cleaning procedure for routine maintenance. Never use a high pressure washer to clean the controller.

1. Remove power by disconnecting the battery.
2. Discharge the capacitors in the controller by connecting a load (such as a contactor coil) across the controller's **B+** and **B-** terminals.
3. Remove any dirt or corrosion from the power and signal connector areas. The controller should be wiped clean with a moist rag. Dry it before reconnecting the battery.
4. Make sure the connections are tight. Refer to Section 2, page 7, for maximum tightening torque specifications for the battery and motor connections.

DIAGNOSTIC HISTORY

The 1311 handheld programmer or the 1314 PC programming station can be used to access the controller's diagnostic history file. The programmer will read out all the faults the controller has experienced since the last time the diagnostic history file was cleared. Faults such as contactor faults may be the result of loose wires; contactor wiring should be carefully checked. Faults such as overtemperature may be caused by operator habits or by overloading.

After a problem has been diagnosed and corrected, it is a good idea to clear the diagnostic history file. This allows the controller to accumulate a new file of faults. By checking the new diagnostic history file at a later date, you can readily determine whether the problem was indeed fixed.

APPENDIX A

VEHICLE DESIGN CONSIDERATIONS REGARDING ELECTROMAGNETIC COMPATIBILITY (EMC) AND ELECTROSTATIC DISCHARGE (ESD)

ELECTROMAGNETIC COMPATIBILITY (EMC)

Electromagnetic compatibility (EMC) encompasses two areas: emissions and immunity. *Emissions* are radio frequency (rf) energy generated by a product. This energy has the potential to interfere with communications systems such as radio, television, cellular phones, dispatching, aircraft, etc. *Immunity* is the ability of a product to operate normally in the presence of rf energy.

EMC is ultimately a system design issue. Part of the EMC performance is designed into or inherent in each component; another part is designed into or inherent in end product characteristics such as shielding, wiring, and layout; and, finally, a portion is a function of the interactions between all these parts. The design techniques presented below can enhance EMC performance in products that use Curtis motor controllers.

Emissions

Signals with high frequency content can produce significant emissions if connected to a large enough radiating area (created by long wires spaced far apart). Contactor drivers and the motor drive output from Curtis controllers can contribute to rf emissions. Both types of output are pulse width modulated square waves with fast rise and fall times that are rich in harmonics. (Note: contactor drivers that are not modulated will not contribute to emissions.) The impact of these switching waveforms can be minimized by making the wires from the controller to the contactor or motor as short as possible and by placing the wires near each other (bundle contactor wires with Coil Return; bundle motor wires separately).

For applications requiring very low emissions, the solution may involve enclosing the controller, interconnect wires, contactors, and motor together in one shielded box. Emissions can also couple to battery supply leads and throttle circuit wires outside the box, so ferrite beads near the controller may also be required on these unshielded wires in some applications. It is best to keep the noisy signals as far as possible from sensitive wires.

Immunity

Immunity to radiated electric fields can be improved either by reducing overall circuit sensitivity or by keeping undesired signals away from this circuitry. The controller circuitry itself cannot be made less sensitive, since it must accurately detect and process low level signals from sensors such as the throttle potentiometer. Thus immunity is generally achieved by preventing the external rf energy from coupling into sensitive circuitry. This rf energy can get into the controller circuitry via conducted paths and radiated paths.

Conducted paths are created by the wires connected to the controller. These wires act as antennas and the amount of rf energy coupled into them is generally proportional to their length. The rf voltages and currents induced in each wire are applied to the controller pin to which the wire is connected. Curtis controllers include bypass capacitors on the printed circuit board's throttle wires to reduce the impact of this rf energy on the internal circuitry. In some applications, additional filtering in the form of ferrite beads may also be required on various wires to achieve desired performance levels.

Radiated paths are created when the controller circuitry is immersed in an external field. This coupling can be reduced by placing the controller as far as possible from the noise source or by enclosing the controller in a metal box. Some Curtis PMC controllers are enclosed by a heatsink that also provides shielding around the controller circuitry, while others are partially shielded or unshielded. In some applications, the vehicle designer will need to mount the controller within a shielded box on the end product. The box can be constructed of just about any metal, although steel and aluminum are most commonly used.

Most coated plastics do not provide good shielding because the coatings are not true metals, but rather a mixture of small metal particles in a non-conductive binder. These relatively isolated particles may appear to be good based on a dc resistance measurement but do not provide adequate electron mobility to yield good shielding effectiveness. Electroless plating of plastic will yield a true metal and can thus be effective as an rf shield, but it is usually more expensive than the coatings.

A contiguous metal enclosure without any holes or seams, known as a Faraday cage, provides the best shielding for the given material and frequency. When a hole or holes are added, rf currents flowing on the outside surface of the shield must take a longer path to get around the hole than if the surface was contiguous. As more "bending" is required of these currents, more energy is coupled to the inside surface, and thus the shielding effectiveness is reduced. The reduction in shielding is a function of the longest linear dimension of a hole rather than the area. This concept is often applied where ventilation is necessary, in which case many small holes are preferable to a few larger ones.

Applying this same concept to seams or joints between adjacent pieces or segments of a shielded enclosure, it is important to minimize the open length of these seams. Seam length is the distance between points where good ohmic contact is made. This contact can be provided by solder, welds, or pressure contact. If pressure contact is used, attention must be paid to the corrosion characteristics of the shield material and any corrosion-resistant processes applied to the base material. If the ohmic contact itself is not continuous, the shielding effectiveness can be maximized by making the joints between adjacent pieces overlapping rather than abutted.

The shielding effectiveness of an enclosure is further reduced when a wire passes through a hole in the enclosure; rf energy on the wire from an external field is re-radiated into the interior of the enclosure. This coupling mechanism

can be reduced by filtering the wire where it passes through the shield boundary. Given the safety considerations involved in connecting electrical components to the chassis or frame in battery powered vehicles, such filtering will usually consist of a series inductor (or ferrite bead) rather than a shunt capacitor. If a capacitor is used, it must have a voltage rating and leakage characteristics that will allow the end product to meet applicable safety regulations.

The B+ (and B-, if applicable) wires that supply power to control panels—such as an electronic throttle, or control wires such as keyswitch, direction, etc.—should be bundled with the other control wires to the panel so that all these wires are routed together. If the wires to the control panel are routed separately, a larger loop area is formed. Larger loop areas produce more efficient antennas which will result in decreased immunity performance.

Keep all low power I/O separate from the motor and battery leads. When this is not possible, cross them at right angles.

ELECTROSTATIC DISCHARGE (ESD)

Curtis motor controllers contain ESD-sensitive components, and it is therefore necessary to protect them from ESD (electrostatic discharge) damage. Most of these control lines have protection for moderate ESD events, but must be protected from damage if higher levels exist in a particular application.

ESD immunity is achieved either by providing sufficient distance between conductors and the ESD source so that a discharge will not occur, or by providing an intentional path for the discharge current such that the circuit is isolated from the electric and magnetic fields produced by the discharge. In general the guidelines presented above for increasing radiated immunity will also provide increased ESD immunity.

It is usually easier to prevent the discharge from occurring than to divert the current path. A fundamental technique for ESD prevention is to provide adequately thick insulation between all metal conductors and the outside environment so that the voltage gradient does not exceed the threshold required for a discharge to occur. If the current diversion approach is used, all exposed metal components must be grounded. The shielded enclosure, if properly grounded, can be used to divert the discharge current; it should be noted that the location of holes and seams can have a significant impact on ESD suppression. If the enclosure is not grounded, the path of the discharge current becomes more complex and less predictable, especially if holes and seams are involved. Some experimentation may be required to optimize the selection and placement of holes, wires, and grounding paths. Careful attention must be paid to the control panel design so that it can tolerate a static discharge.

MOV, transorbs, or other devices can be placed between B- and offending wires, plates, and touch points if ESD shock cannot be otherwise avoided.

APPENDIX B PROGRAMMERS

Curtis programmers provide programming, diagnostic, and test capabilities for the 1230 controller. The power for operating the programmer is supplied by the host controller via a 4-pin connector. Two programmers are available: the PC Programming Station (1314) and the handheld programmer (1311). The Programming Station has features not available on the handheld unit; on the other hand, the handheld programmer has the advantage of being more portable. Typically the Programming Station is used to set up the parameters initially and the handheld programmer is used to make adjustments in the field.

Two versions of each programmer are available: the User programmers can adjust only User-access parameters, whereas the OEM programmers can adjust all the parameters.

HANDHELD PROGRAMMER (1311)

The 1311 programmer is easy to use, with self-explanatory functions. After plugging in the programmer, wait a few seconds for it to boot up and gather

Fig. B-1 *Curtis 1311 handheld programmer.*

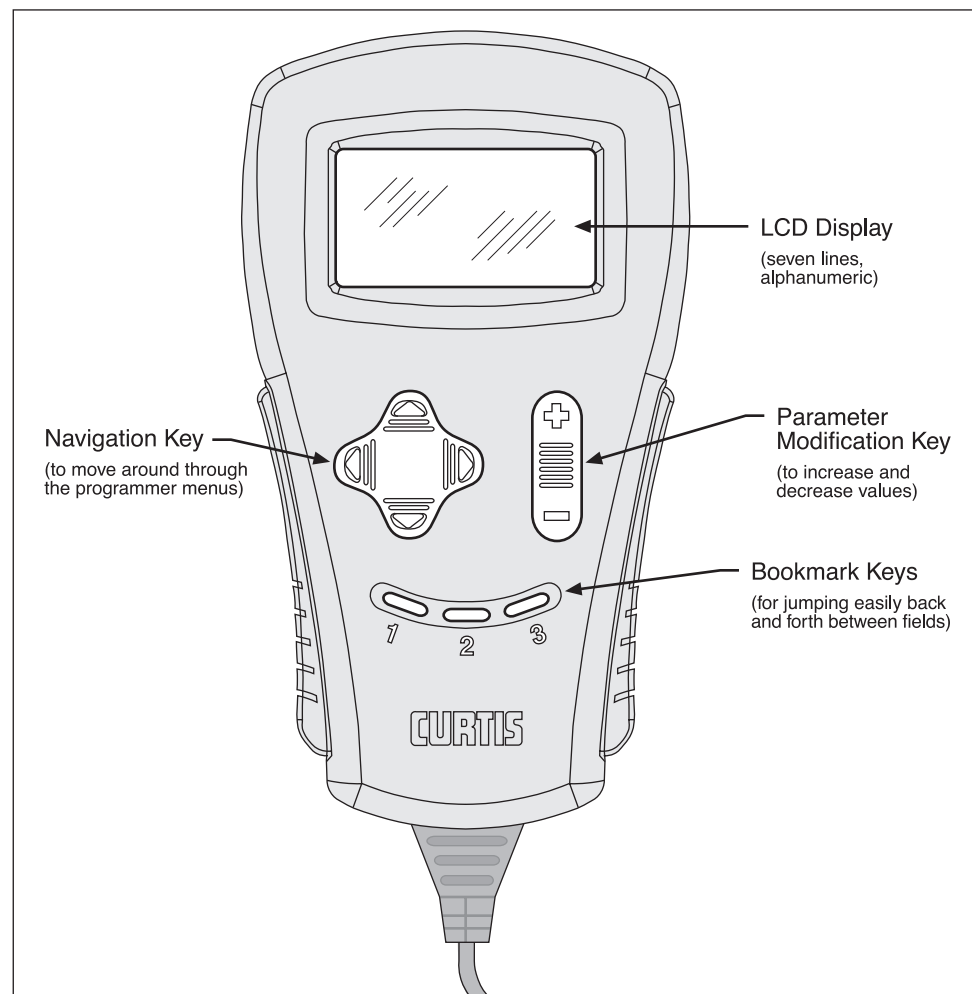

information from the controller. For experimenting with settings, the programmer can be left plugged in while the vehicle is driven.

The bookmark keys can make parameter adjustment more convenient. For example, in setting the throttle deadband parameter, you might set a bookmark at this parameter in the Throttle submenu [Program > *Throttle* > Throttle Deadband] and another at the throttle readout [Monitor > *Inputs* > Throttle Input]; this way you can easily toggle between the readout and the parameter.

To set a bookmark, press one of the three bookmark keys for more than two seconds. To jump to a bookmarked location, press the appropriate bookmark key quickly (for less than two seconds).

The bookmark keys also have another function that makes programming easier. When setting the value of a parameter, you can use these keys to adjust the increments by which the value changes—with Bookmark Key 1, the value changes in 10-digit steps up or down; with Bookmark Key 2 pressed, the value changes in 100-digit steps; and with Bookmark Key 3, in 1000-digit steps—which, for most parameters, takes you from the maximum to the minimum, or vice versa.

PC PROGRAMMING STATION (1314)

The Programming Station is an MS-Windows 32-bit application that runs on a standard Windows PC. It can do everything the handheld programmer can do, and more. Its additional capabilities include saving/restoring sets of parameters to/from disk and updating software. Instructions for using the Programming Station are included with the software.

PROGRAMMER MENUS

The programmers have six menus:

Program — provides access to the individual programmable parameters.

Monitor — presents real-time values during vehicle operation; these include all inputs and outputs.

Faults — presents diagnostic information, and also a means to clear the fault history file.

Functions — provides access to the controller-cloning commands and to the “reset” command.

Information — displays data about the host controller: model and serial numbers, date of manufacture, hardware and software revisions, and itemization of other devices that may be associated with the controller’s operation.

Programmer Setup — displays data about the programmer: model and serial numbers, and date of manufacture.

APPENDIX C

SPECIFICATIONS

Table C-1 SPECIFICATIONS: 1230 CONTROLLER

| | |
|---|--|
| Operating voltage range | 16 to 32V |
| Nominal input voltage | 24 V |
| PWM operating frequency | 16 kHz |
| Electrical isolation to heatsink | 500 V ac (minimum) |
| KSI input current (no contactors engaged) | 90 mA without programmer or speed encoder 170 mA with programmer and SKF speed encoder |
| Logic input voltage | >7.5 V High; <1 V Low |
| Logic input current | 10 mA (nominal) |
| Nominal output line-to-line voltage (rms) | 15 V |
| Max. output frequency | >200 Hz |
| Operating ambient temp. range | -40°C to 50°C (-40°F to 122°F) |
| Storage ambient temperature range | -40°C to 85°C (-40°F to 185°F) |
| MOSFET overtemperature cutback | linear cutback starts at 100°C (212°F); complete cutoff at 110°C (230°F) |
| MOSFET undertemperature cutback | approx. 50% motor current at -25°C (-13°F); complete cutoff at -40°C (-40°F) |
| Package environmental rating | IP53 |
| Weight | 1.1 kg (2.2 lbs) |
| Dimensions (LxWxH) | 164 × 146 × 57 mm (6.5" × 5.8" × 2.3") |
| Regulatory compliance | EMC emissions: EN50081-2/08.93 EMC immunity: EN50082-2: 1995 Safety, uncontrolled runaway: EN1175 UL Recognized Component; meets UL583 dielectric test. |

| MODEL NUMBER | NOMINAL BATTERY VOLTAGE (volts) | 2 MIN RATING * (amps) | 1 HOUR RATING * (amps) | MODEL-SPECIFIC FEATURES | | | |
|--------------|---------------------------------|-----------------------|------------------------|-------------------------|----------------------------|-----------------------|---------------|
| | | | | INTERNAL MAIN CONTACTOR | 1312 MULTIPLEXER INTERFACE | TWO AUXILIARY OUTPUTS | CAN INTERFACE |
| 1230-2001 | 24 | 60 | 30 | ✓ | ✓ | ✓ | — |
| -2002 | 24 | 60 | 30 | — | — | — | — |
| 1230-2101 | 24 | 90 | 40 | ✓ | ✓ | ✓ | — |
| -2102 | 24 | 90 | 40 | — | — | — | — |
| 1230-2201 | 24 | 120 | 50 | ✓ | ✓ | ✓ | — |
| -2202 | 24 | 120 | 50 | — | — | — | — |
| 1230-2301 | 24 | 150 | 60 | — | ✓ | ✓ | — |
| -2302 | 24 | 150 | 60 | — | — | — | — |
| 1230-2401 | 24 | 200 | 80 | — | ✓ | ✓ | — |
| -2402 | 24 | 200 | 80 | — | — | — | — |
| -2403 | 24 | 200 | 80 | — | — | ✓ | ✓ |

* Controller mounted to 250 × 250 × 5 mm aluminum plate, with continuous 5 kph airflow perpendicular to back of plate, and 25°C ambient temperature.